



# Activity Report Specifications

---

Version: 1.54

Date: January 28, 2019

Author: Valerie Smothers

Author email:

[vsmothers@jhmi.edu](mailto:vsmothers@jhmi.edu)

## Version History

Version No.	Date	Changed By	Changes Made
1.0	26 August 2009		
1.1	3 February 2012	Valerie Smothers	Added arid attribute to ActivityReports and ActivityReport; added extensibility via xsd:any to ActivityReport.
1.2	6 March 2012	Valerie Smothers	Added extensibility via xsd:any to ActivityReports, Module, and Activity.
1.21	11 October 2012	Valerie Smothers	Clarified Module definition.
1.3	22 July 2013	Valerie Smothers	Added ActivityInstanceID, LaunchAction, ActivityLocation, ReturnLocation, Results (to Activity)
1.4	5 September 2013	Valerie Smothers	Added Status element to activity, modified Activity datamodel, clarified definitions of Launch Action and Return Location.
1.5	20 April 2018	Valerie Smothers	Added elements to support REMS: ReportingStartDate, ReportingEndDate, Participants, Commercial Supporter, RegulatoryInformation
1.51	28 August 2018	Valerie Smothers	Made Status under Module optional. Added veterinarian to list of professions. Modified YearsInPractice value to include 0-5 years post-training. Changed NonNullString references to NonNullStringType in common schema. Added ReportingStartDate and ReportingEndDate. Added Sample XML for Opioid REMS.
1.52	29 November 2018	Valerie Smothers	Made the following optional: StateOfPrimaryPractice, DEARegistration, PracticeArea, SurgicalProcedures, TimeInPractice

---

1.53	2 January 2019	Valerie Smothers	Corrected TimeInPractice value to include 0-5 years post training instead of >5 years post training.
1.54	28 January 2019	Valerie Smothers	Changed Addiction to Substance Use Disorder to reflect FDA documentation.

## MedBiquitous Standards Public License And Terms Of Use

MedBiquitous Standards (including schemas, specifications, guidelines, sample documents, sample code, Web services description files, and related items) are provided by the copyright holders under the following license. By obtaining, using, and or copying this work, you (the licensee) agree that you have read, understood, and will comply with the following terms and conditions.

The Consortium hereby grants a perpetual, non-exclusive, non-transferable, license to copy, use, display, perform, modify, make derivative works of, and develop the MedBiquitous Standards for any use and without any fee or royalty, provided that you include the following on ALL copies of the MedBiquitous Standards or portions thereof, including modifications, that you make.

Any pre-existing intellectual property disclaimers, notices, or terms and conditions. If none exist, the following notice should be used: "Copyright © [date of release] MedBiquitous Consortium. All Rights Reserved. <http://www.medbiq.org>"

Notice of any changes or modification to MedBiquitous Standards files.

Notice that any user is bound by the terms of this license and reference to the full text of this license in a location viewable to users of the redistributed or derivative work.

In the event that the licensee modifies any part of the MedBiquitous Standards, it will not then represent to the public, through any act or omission, that the resulting modification is an official specification of the MedBiquitous Consortium unless and until such modification is officially adopted.

THE CONSORTIUM MAKES NO WARRANTIES OR REPRESENTATIONS, EXPRESS OR IMPLIED, WITH RESPECT TO ANY COMPUTER CODE, INCLUDING SCHEMAS, SPECIFICATIONS, GUIDELINES, SAMPLE DOCUMENTS, WEB SERVICES DESCRIPTION FILES, AND RELATED ITEMS. WITHOUT LIMITING THE FOREGOING, THE CONSORTIUM DISCLAIMS ANY IMPLIED WARRANTIES OF MERCHANTABILITY OR FITNESS FOR A PARTICULAR PURPOSE AND ANY WARRANTY, EXPRESS OR IMPLIED, AGAINST INFRINGEMENT BY THE MEDBIQUITOUS STANDARDS OF ANY THIRD PARTY PATENTS, TRADEMARKS, COPYRIGHTS OR OTHER RIGHTS. THE LICENSEE AGREES THAT ALL COMPUTER CODES OR RELATED ITEMS PROVIDED SHALL BE ACCEPTED BY LICENSEE "AS IS". THUS, THE ENTIRE RISK OF NON-PERFORMANCE OF THE MEDBIQUITOUS STANDARDS RESTS WITH THE LICENSEE WHO SHALL BEAR ALL COSTS OF ANY SERVICE, REPAIR OR CORRECTION.

IN NO EVENT SHALL THE CONSORTIUM OR ITS MEMBERS BE LIABLE TO THE LICENSEE OR ANY OTHER USER FOR DAMAGES OF ANY NATURE, INCLUDING, WITHOUT LIMITATION, ANY GENERAL, DIRECT, INDIRECT, INCIDENTAL, CONSEQUENTIAL, OR SPECIAL DAMAGES, INCLUDING LOST PROFITS, ARISING OUT OF ANY USE OF MEDBIQUITOUS STANDARDS.

LICENSEE SHALL INDEMNIFY THE CONSORTIUM AND EACH OF ITS MEMBERS FROM ANY LOSS, CLAIM, DAMAGE OR LIABILITY (INCLUDING, WITHOUT LIMITATION, PAYMENT OF ATTORNEYS' FEES AND COURT COSTS) ARISING OUT OF MODIFICATION OR USE OF THE MEDBIQUITOUS STANDARDS OR ANY RELATED CONTENT OR MATERIAL BY LICENSEE.

LICENSEE SHALL NOT OBTAIN OR ATTEMPT TO OBTAIN ANY PATENTS, COPYRIGHTS OR OTHER PROPRIETARY RIGHTS WITH RESPECT TO THE MEDBIQUITOUS STANDARDS.

THIS LICENSE SHALL TERMINATE AUTOMATICALLY IF LICENSEE VIOLATES ANY OF ITS TERMS AND CONDITIONS.

The name and trademarks of the MedBiquitous Consortium and its members may NOT be used in advertising or publicity pertaining to MedBiquitous Standards without specific, prior written permission. Title to copyright in MedBiquitous Standards and any associated documentation will at all times remain with the copyright holders.

## Table of Contents

1	Acknowledgements.....	7
2	Documentation Conventions .....	10
3	Conformance.....	11
4	Common Data Types.....	12
5	Introduction .....	13
6	Other Standards, Specifications, or Schemas Referenced.....	15
7	Activity Report Schema.....	16
7.1	ActivityReports.....	16
8	ActivityReport .....	18
8.1	Participants .....	22
8.2	Participant.....	23
9	Activity .....	25
10	LaunchDetails.....	29
10.1	RegulatoryInformation.....	30
10.1.1	RegulatoryClassification.....	32
11	Module.....	34
11.1	Metadata.....	39
11.2	CreditCertificate.....	40
11.3	CreditReceived .....	43
11.4	Credit Focus.....	44
12	PointOfCareLearning.....	46
12.1	ResourceUsed .....	48
13	XtensibleInfo .....	51
14	Sample XML Documents .....	52
14.1	CE Credit Example.....	52
14.2	Opioid REMS Example.....	53
15	References .....	55

# 1 Acknowledgements

The MedBiquitous Consortium wishes to acknowledge the MedBiquitous Metrics Working Group members, Activity Report Working Group Members, invited experts, and other individuals that contributed to the creation of this document.

## Chairs

- Francis Kwakwa, Radiological Society of North America, Chair, Metrics Working Group
- James Fiore, American Board of Surgery, Chair, Activity Report Working Group

## Members

- Pamela Ball, American Osteopathic Association
- Brynn Barker, Syneos Health
- Caitlin Briggs, Syneos Health
- Kathy Chappell, American Nurses Credentialing Center
- Prasad Chodavarapu, American Board of Family Medicine
- Jemma Contreras, Syneos Health
- Lindsay Crampton, Syneos Health
- Jennifer Dunleavy, Accreditation Council of Continuing Medical Education
- Koffi Harrison, Syneos Health
- Nyssa Hoch, Syneos Health
- Jyothi Holla, American Board of Pediatrics
- Edward Kennedy, Accreditation Council for Continuing Medical Education
- Hellen Kim, Syneos Health
- Marissa Kronk, Syneos Health
- Jack Kues, Ph.D., University of Cincinnati
- Purvi Maniar, American Board of Medical Specialties
- Jennifer Michael, American Board of Medical Specialties
- Alex Minkovsky, American Board of Surgery
- Rahul Natarajan, Syneos Health
- Nadia Ouhib, Syneos Health
- Kate Regnier, Accreditation Council of Continuing Medical Education
- Barb Rosenthal, American Board of Medical Specialties
- Peter Samoulian, American Board of Pediatrics
- Brianne Scheiber, Syneos Health
- Tarang Shah, American Osteopathic Information Association
- Anum Sheraz, Syneos Health
- Lorraine Spencer, Johns Hopkins University School of Medicine

- John Sweeney, Accreditation Council for Continuing Medical Education
- Amy Tan, Syneos Health
- Elizabeth Waligoria, Syneos Health
- John West, Syneos Health

#### Invited Experts

- Mary Ales, Interstate Postgraduate Medical Association
- Mark Baczkowski, Mylan
- Robin Barrale, Tevapharm
- Pamela Bennett, Pharma
- Leslie Christy, American Academy of Family Physicians
- Jocelyn Clark-Greuel, Perrigo
- Ekene Daniel, Polaris
- Siobhan Duffy, Maynepharm
- Kal Elhoregy, Amneal Pharmaceuticals
- Lisa Fennell, Association of Regulatory Boards of Optometry
- Susie Flynn, American Academy of Pain Medicine
- Bradley Hamilton, West-Ward Pharmaceuticals
- Ilana Hardesty, Boston University School of Medicine
- Amy Holthusen, Interstate Post-Graduate Medical Association
- Xavier Hudson, Johnson & Johnson
- Cynthia Kear, California Academy of Family Physicians
- David Kern, Johnson & Johnson
- Linda Kitlinski
- Joanna Krause, Boston University School of Medicine
- Tina Latch, Endo
- Tom McKeithen, Changing Performance
- Suzanne McLeod, West-Ward
- Reema Mehta, Pfizer
- Stephanie Mercado, American Academy of Physical Medicine and Rehabilitation
- Linda Noa, Mallinckrodt
- Rajesh Patel, Polaris
- Sophie Peloquin, AxDev
- John Peppin, Johnson & Johnson
- Sharon Reid, Pfizer
- Shelly Rodrigues, California Academy of Family Physicians
- Harpreet Sandhu, Kashiv Pharma
- Marissa Seligman, Pri-med
- Amy Smith, American Academy of Family Physicians
- Marsha Stanton, PainAdvocate



- Kurt Strittmatter, Egalet
- Brian Sullivan, Purdue Pharma
- Roshan Tiwari, Kashiv Pharma
- Dimitra Travlos, Accreditation Council for Pharmacy Education
- Mark Tyrrell, Impax Laboratories
- Toby Vandemark
- Ekaterina Walker, Pharma
- Julie White, Boston University School of Medicine
- John-Peter Zak, Novartis
- Lara Zisblatt, Boston University School of Medicine
- Michelle Zachman, Upsher-Smith

#### Liaison

- Doris Auth, Food and Drug Administration

## 2 Documentation Conventions

This document uses the following conventions:

Convention	Description
<b>Bold Text</b>	When used with an XML element name, indicates that the element contains sub-elements.
<i>Italics</i>	When used in an XML element description, an attribute of the XML element.
Monospaced type	Sample XML tags, code, schema, or portion thereof.

The document uses graphics generated by Altova XML Spy® software, which uses the following graphical conventions.

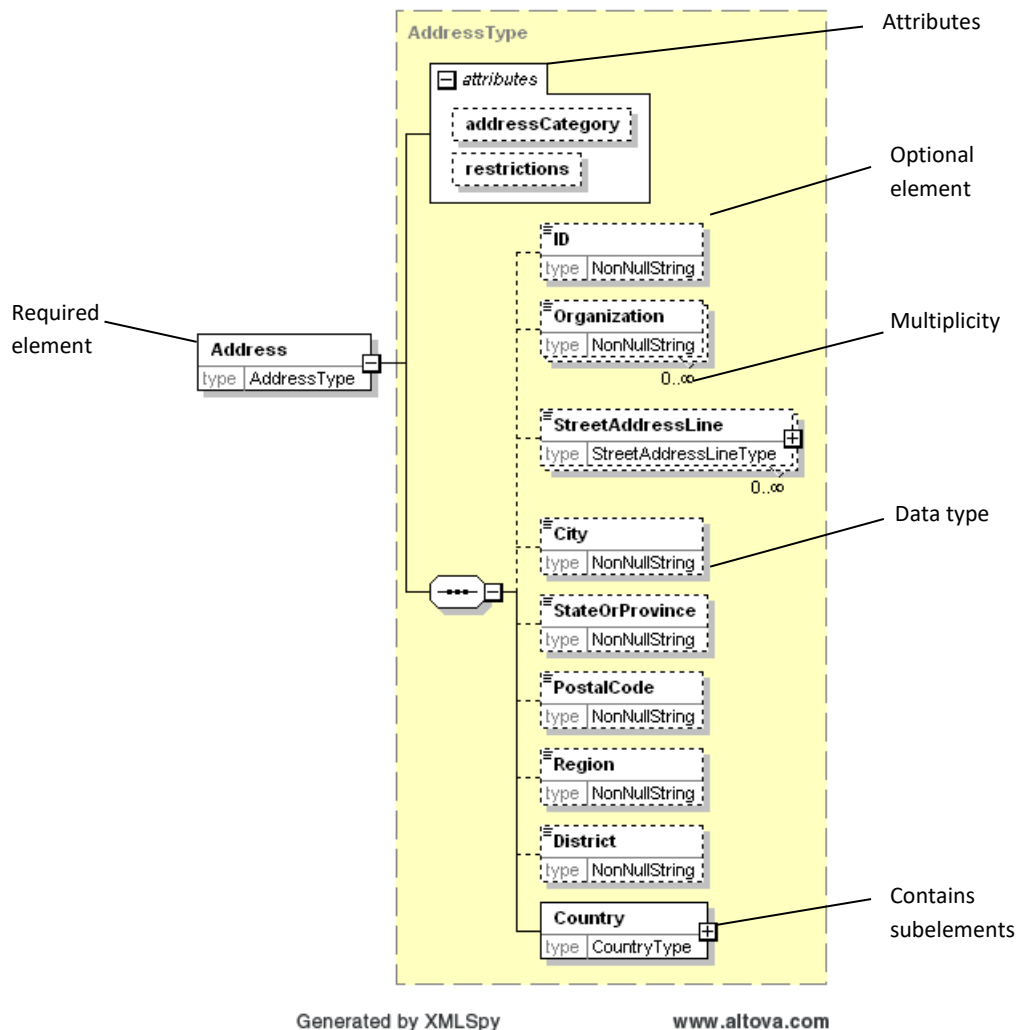

### 3 Conformance

To conform to the Standard Name specification, an XML document shall:

- Validate against the Activity Report XML Schema available at:  
<http://ns.medbiq.org/activityreport/v2/activityreport.xsd>
- Conform to any additional requirements stated in this specification.
- Optionally include elements not defined in this document only in permitted areas and only if those elements are namespace qualified.

## 4 Common Data Types

Most of the elements and attributes in MedBiquitous XML documents use the data types defined by the W3C XML schema definition [XSD]. In some cases MedBiquitous creates its own datatypes as part of its best practices or to meet a specific requirement. Commonly used datatypes are defined in the common.xsd file. For more information about common datatypes, see:

<http://www.medbiq.org/sites/default/files/CommonSpecifications.pdf>

## 5 Introduction

This document describes the MedBiquitous Consortium Activity Report XML Schema in detail. It is intended for use by anyone who wants to develop tools or implement electronic systems to:

- Track the learning and certification activities of physicians and other medical professionals, or
- Share learner demographic data for learning activities related to regulatory actions, such as the US Food and Drug Administration (FDA) Risk Evaluation and Mitigation Strategy (REMS) for Opioids.

The objective of this Activity Report Schema is to provide a data structure that allows one to represent the educational and maintenance of competence activities of physicians and other medical professionals in a standard format. The Activity Report also provides a data structure for representing learner-level demographics for those individuals participating in a learning activity. This structure then enables the exchange of activity report information between related business systems and over the Web.

Within professional medicine, there is a need for societies, certifying boards, licensing entities, and other organizations to exchange information about the educational activities of physicians and other medical professionals. Professional societies often serve as the providers of medical education and other resources to enhance the competency of physicians and other medical professionals. Many certifying boards track these educational and competency activities as part of their requirements for maintaining certification.

In addition, educators, accrediting bodies, CE supporters, and government agencies may collect demographic data for activities supporting regulatory actions in order to measure the reach of educational activities and analyze the learner population that is receiving, or not receiving, the education.

The Activity Report Schema provides a lingua franca for the structure of this data and facilitates the educational and public service missions of these organizations and others. The schema in no way compromises the confidentiality, integrity, or security of activity data.

The Activity Report also provides a way to represent Point of Care Learning data. The American Academy of Family Physicians (AAFP) defines point of care learning as “practice-based learning that takes place in support of specific patient care.” Clinicians often use point-of-care learning products to answer clinical questions. Other types of evidence-based clinical literature may be used at point of care as well.

In 2005, the American Medical Association (AMA) Physician’s Recognition Award (PRA) and Credit System and the American Academy of Family Physicians (AAFP) Credit System began to award Continuing Medical Education (CME) credit for Internet Point of Care learning. In order to claim CME credit, the AMA and AAFP require learners to review the clinical question, identify relevant sources, and describe the application of findings to practice. This specification enables the exchange of such data. While credit may be awarded for point-of-care learning activities, this specification is intended for use

with a broad scope of point-of-care learning activities regardless of whether or not credit is designated or awarded.

This Activity Report Schema forms a portion of MedBiquitous' technology blueprint for medical education and is part of its overall XML framework and software architecture for professional medicine.

## 6 Other Standards, Specifications, or Schemas Referenced

This standard references the following standards, specifications, or schemas. The informative references here, which describe how these references are used, link to formal references appearing later in this document.

- ANSI/MEDBIQ PP.10.1-2008, Healthcare Professional Profile [[Professional Profile](#)]  
The Professional Profile provides a common format for information describing the individual healthcare professional, including name, address, institution, licensure, certification, and more.
- ANSI/MEDBIQ LO.10.1-2008, Healthcare Learning Object Metadata [[Healthcare LOM](#)]  
Healthcare LOM extends the IEEE LOM standard and provides a format for describing healthcare learning resources and activities. Vocabularies and datatypes from Healthcare LOM are used in the Curriculum Inventory.

## 7 Activity Report Schema

The following sections explain the Activity Report Schema grammar. Values in **bold** under XML Tags column indicate that the element has sub-elements.

All the elements having sub-elements will be defined in separate sections. All elements without sub-elements will be defined within the appropriate element sections that use them.

### 7.1 ActivityReports

ActivityReports is the root element. It contains information on registration for, completion of, or expiration of learning activities, maintenance of competence activities, or other relevant activities for one or more healthcare professionals. ActivityReports must occur once within an activity report.

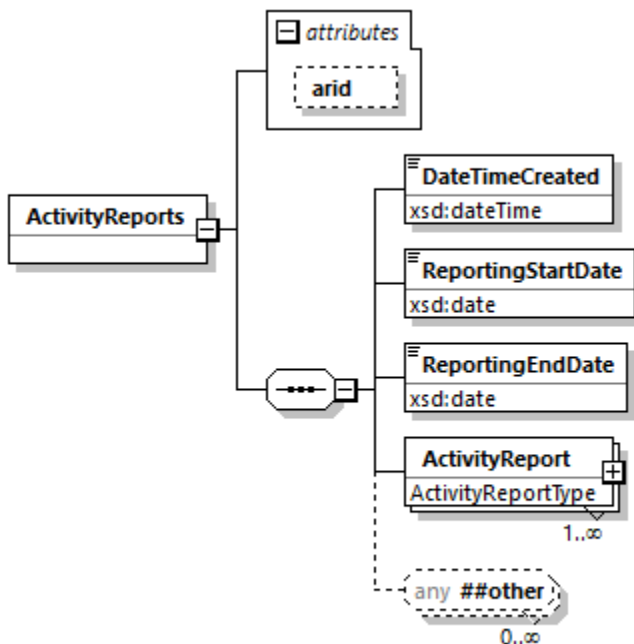

Generated by XMLSpy

www.altova.com

#### Element Information

Element	Description	Required	Multiplicity	Datatype
<b>ActivityReports</b>	Contains information on registration for, completion of, or expiration of learning activities, maintenance of competence activities, or other relevant activities for one or more	Required	1	Container



	<p>healthcare professionals. ActivityReports has the following attribute:</p> <p><i>arid</i> a globally unique identifier for this XML document. The arid attribute uses the arid Uniform Resource Name (URN) format as shown below:</p> <p><i>arid:domain:localidentifier</i></p> <p><i>domain</i> is a the domain name that uniquely identifies the organization issuing the Activity Reports document.</p> <p><i>localidentifier</i> is a locally unique identifier for the Activity Reports document created by the organization issuing the document.</p>			
<b>DateTimeCreated</b>	Defines the date and time this set of reports was created. For example: 2018-01-23T09:00:00 Indicates January 23, 2018, 9 AM.	Required	1	dateTime
<b>ReportingStartDate</b>	Defines the first day of the reporting period for the data in this activity report. For example, 2018-01-23 indicates January 23, 2018.	Required	1	date
<b>ReportingEndDate</b>	Defines the last day of the reporting period for the data in this activity report. For example, 2018-01-23 indicates January 23, 2018.	Required	1	date
<b>ActivityReport</b>	Contains subelements that define the activities of a single person. See section ActivityReport for more information.	Required	1 or more	Container

Any	The ActivityReports element may contain any elements defined by the organization implementing the schema provided those elements are defined in another namespace. This is the preferred method of extension.	Optional	0 or more	Any datatype
-----	---------------------------------------------------------------------------------------------------------------------------------------------------------------------------------------------------------------	----------	-----------	--------------

**Example:**

```

<ActivityReports>
  <DateTimeCreated>2018-08-23T09:00:00</DateTimeCreated>
  <ReportingStartDate>2018-01-01<ReportingStartDate>
  <ReportingEndDate>2018-06-30</ReportingEndDate>
  <ActivityReport>
    ...
  </ActivityReport>
  <ActivityReport>
    ...
  </ActivityReport>
</ActivityReports>

```

**8 ActivityReport**

ActivityReport is the subelement of ActivityReports. ActivityReport contains subelements that define the activities of a single physician or medical professional. ActivityReport is required and may occur multiple times.

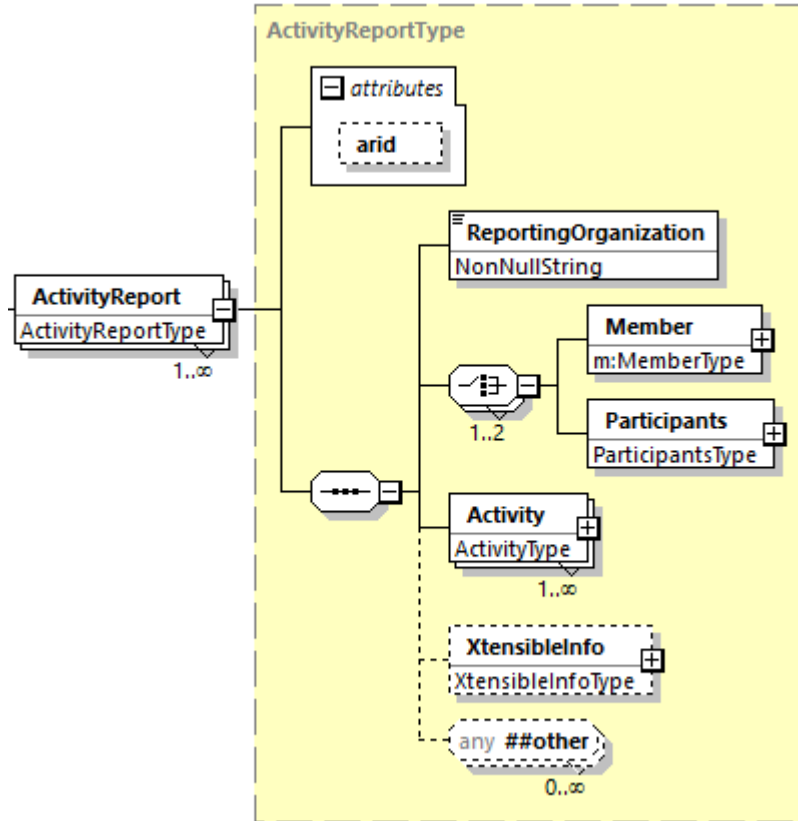

**ActivityReport Element Information**

Element	Description	Required	Multiplicity	Datatype
<b>ActivityReport</b>	ActivityReport is the subelement of ActivityReports. It contains subelements that define the activities of a single person. ActivityReport has the following attribute: <i>arid</i> a globally unique identifier for this activity report. The arid attribute uses the arid Uniform Resource Name (URN) format as shown below: <i>arid:domain:localidentifier</i>	Required	1 or more	Container

	<p><i>domain</i> is a the domain name that uniquely identifies the organization issuing the Activity Report.</p> <p><i>localidentifier</i> is a locally unique identifier for the Activity Report created by the organization issuing the report.</p>			
ReportingOrganization	ReportingOrganization is the sub-element of the ActivityReport element that defines the name of the organization that is the source of the activity report.	Required	1	NonNullString
<b>Member</b>	Member is imported from the MedBiquitous Professional Profile schema. It contains subelements that define name and profile information for a single person. Member is a sub-element of ActivityReport. See the <i>MedBiquitous Healthcare Professional Profile Specifications and Description Document</i> for more information.	Member and/or Participants is Required	0 to 1	Container (See <i>MedBiquitous Healthcare Professional Profile Specifications and Description Document</i> for more information)
<b>Participants</b>	Describes demographic data about the learners that participated in the described activity. See section Participants for more information.	Member and/or Participants is Required	0 to 1	Container
<b>Activity</b>	This is the sub-element of the ActivityReport element. It defines one activity and its status for one person. See section Activity for more information.	Required	1 or more	Container
XtensibleInfo	XtensibleInfo is the subelement of Member.	Optional	0 or 1	Container

	XtensibleInfo contains sub-elements defined by the organization implementing the schema. See section XtensibleInfo for more information. XtensibleInfo is included for backward compatibility and is not the preferred method of extension.			
<b>Any</b>	The ActivityReport element may contain any elements defined by the organization implementing the schema provided those elements are defined in another namespace. This is the preferred method of extension.	Optional	0 or more	Any datatype

## Example 1:

```

<ActivityReport>
  <ReportingOrganization>HighWire Press</Organization>
  <m:Member>
    <m:Name>
      <n:GivenName>Percy</n:GivenName>
      <n:GivenName>Bysshe</n:GivenName>
      <n:FamilyName>Shelley</n:FamilyName>
      <n:Degree>MD</n:Degree>
    </m:Name>
  </m:Member>
  <Activity>
    . . .
  </Activity>

```

## Example 2:

```

<ActivityReport>
  <ReportingOrganization>Nonesuch University</ReportingOrganization>
  <Participants>
    <Participant>
      . . .
    </Participant>
    <Participant>
      . . .
    </Participant>

```

```

    <Participant>
      . . .
    </Participant>
  </Participants>
</Activity>
. . .
</Activity>

```

## 8.1 Participants

Participants describes demographic data about the learners that participated in the described activity.

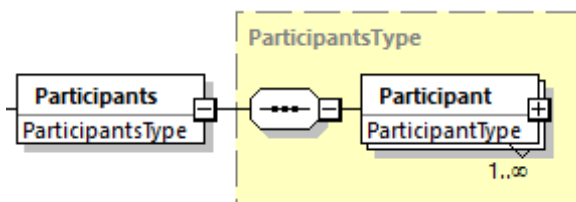

### Participants Element Information

Element	Description	Required	Multiplicity	Datatype
<b>Participants</b>	Describes demographic data about the learners that participated in the described activity.	Member and/or Participants is Required	0 to 1	Container
<b>Participant</b>	Contains subelements that describe demographic details for a single learner. See section Participant for more information.	Required	1 or more	Container

Example:

```

<Participants>
  <Participant>
    . . .
  </Participant>
  <Participant>
    . . .
  </Participant>
  <Participant>
    . . .
  </Participant>
</Participants>

```

## 8.2 Participant

Participant contains subelements that describe demographic details for a single learner.

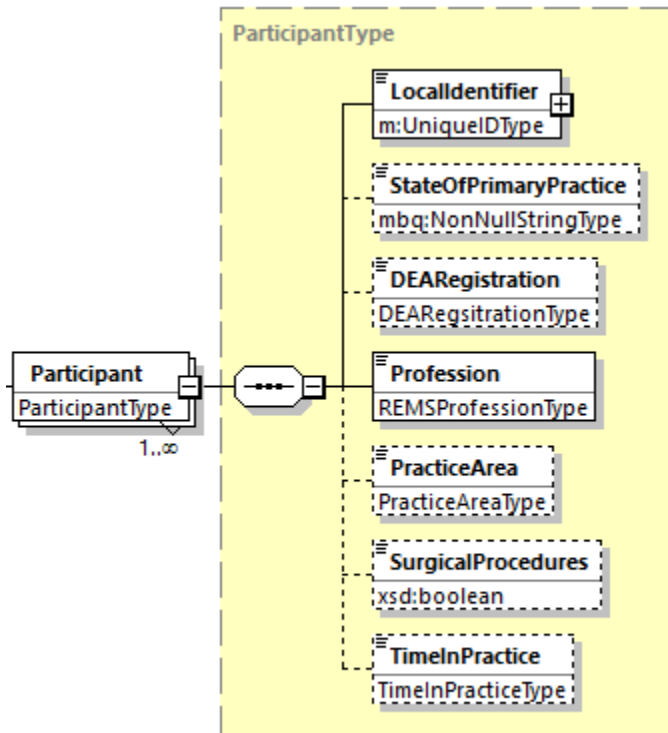

Generated by XMLSpy

www.altova.com

### Participants Element Information

Element	Description	Required	Multiplicity	Datatype
<b>Participant</b>	Contains subelements that describe demographic details for a single learner.	Required	1 or more	Container
LocalIdentifier	LocalIdentifier defines an alphanumeric identifier for the learner used internally by the reporting organization. The LocalIdentifier allows the reporting organization to identify the learner for auditing purposes, but does not allow other organizations to identify the learner.	Required	1	Non-null String

	<p>LocalIdentifier has the following attribute:</p> <p><i>domain</i> Provides a unique identifier describing the type of ID described by LocalIdentifier. Domain has the following format:</p> <p><i>idd:domainname:localidentifier</i></p> <p>Where:</p> <p><i>domainname</i> is an internet domain name owned by the organization issuing the unique ID and</p> <p><i>localidentifier</i> is a local identifier for the type of unique ID.</p> <p>For example: <i>idd:aamc.org:famous</i> Use of the domain attribute is required when using the LocalIdentifier element.</p>			
StateOfPrimaryPractice	The state that the learner has identified as being the primary state in which he or she practices.	Optional	0 or 1	Non-null String
DEARegistration	Indicates whether or not the learner is able to prescribe controlled substances, and if so, the type of registration which allows him or her to do so. Valid values are: Individual, Institutional, None.	Optional	0 or 1	Restricted
Profession	The learner's profession. Valid values are: Physician, Advanced practice nurse, Physician Assistant, Dentist, Podiatrist, Nurse, Pharmacist, Optometrist, Psychologist,	Required	1	Restricted



	Other health care professional, Other.			
PracticeArea	The clinical area in which the learner practices. Valid values are: Anesthesiology, Critical Care, Dentistry, Emergency, Family Medicine, Geriatric, Hematology, Hospice and/or Palliative Care, Internal Medicine, Neurology, Obstetrics/Gynecology, Oncology, Ophthalmology, Pain, Pediatric, Physical Medicine and Rehabilitation, Psychiatry, General surgery, Orthopedic surgery, Other surgical specialty, Substance Use Disorder, Urology, Other, N/A.	Optional	0 or 1	Restricted
SurgicalProcedures	Indicates whether the learner performs surgical procedures.	Optional	0 or 1	Boolean
TimeInPractice	The length of time the learner has been in practice. Valid values are: Trainee (e.g., student, intern, resident, fellow), 0-5 years post training, 6-10 years, 11-15 years, 16-20 years, 21+ years.	Optional	0 or 1	Restricted

Example:

```
<Participant>
  <LocalIdentifier domain="idd:nonesuch.edu:ce">H046431</LocalIdentifier>
  <StateOfPrimaryPractice>Michigan</StateOfPrimaryPractice>
  <DEARegistration>Individual</DEARegistration>
  <Profession>Physician</Profession>
  <PracticeArea>General Surgery</PracticeArea>
  <SurgicalProcedures>true</SurgicalProcedures>
  <TimeInPractice>0-5 years post training</TimeInPractice>
</Participant>
```

## 9 Activity

The Activity element identifies the type of educational or other activity completed or started by an individual. For example, in pediatrics this may be eQIPP or PREP SA (both of which are activities that can be applied towards a pediatrician's maintenance of certification requirements in the US). If Activity Report is describing an individual's educational accomplishments or learner demographics for a specific

activity, the activity element describes a continuing education activity. The Activity element is a subelement of ActivityReport. Activity may occur multiple times and is required.

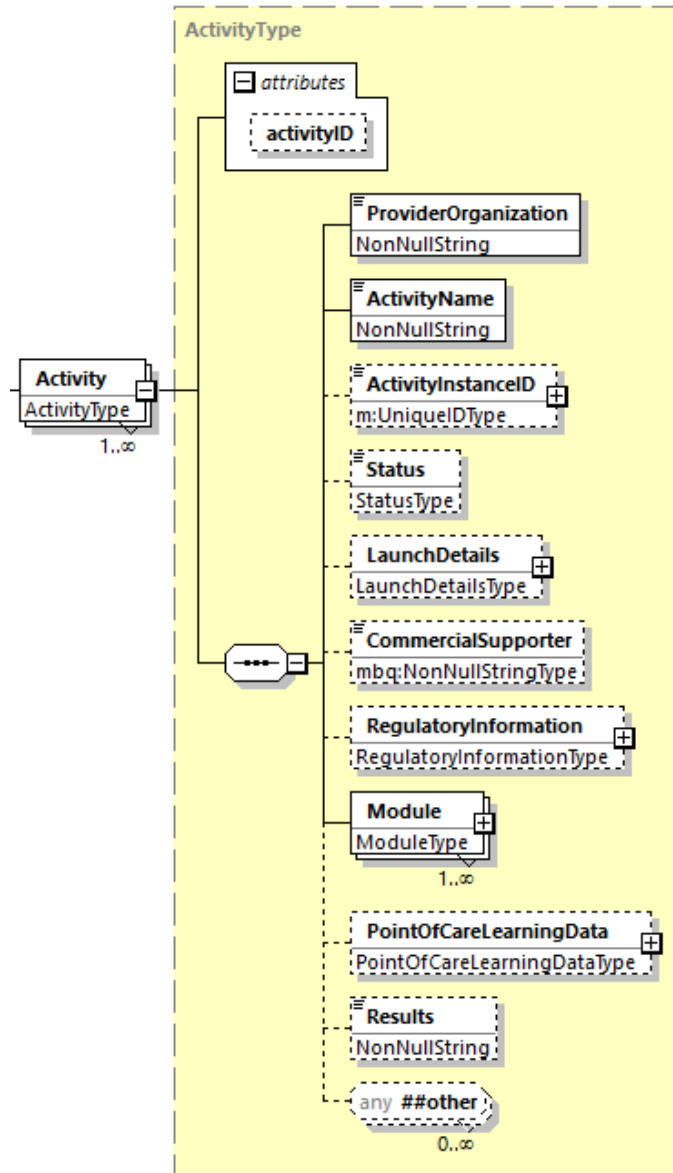

**Activity Element Information**

Element	Description	Required	Multiplicity	Datatype
<b>Activity</b>	The Activity element is a subelement of ActivityReport. Activity has one attribute: <i>activityID</i> A unique identifier for this activity.	Required	1 or more	Container
ProviderOrganization	This is the sub-element of the Activity element. ProviderOrganization defines the name of the organization that is the official provider of this activity. For continuing education activities, ProviderOrganization is the accredited CE provider.	Required	1	NonNullString
ActivityName	This is the sub-element of the Activity element. It defines the name of the activity completed. For example, PREP Self Assessment. If the Activity Report describes a continuing education activity, ActivityName is the title of the educational activity or course.	Required	1	NonNullString
ActivityInstanceID	An alphanumeric identifier for this instance of the activity. ActivityInstanceID has the following attribute: <i>domain</i> Defines the organization that is the source of the unique identifier. <i>domain</i> has the following format:  <i>idd:domainname:localidentifier</i> Where: <i>domainname</i> is internet domain name that is a valid URN authority (see RFC 3986 - <a href="#">URI</a> ) and is owned by the organization issuing the unique ID.  and	Optional	0 or 1	NonNullString

	<p><i>localidentifier</i> is a local identifier for the type of unique ID. For example: idd:absurgery.org:instance Use of the domain attribute is required when using the ActivityInstanceID element.</p>			
Status	The individual's status in relation to this activity. Valid values are registered, completed, and expired.	Optional	0 or 1	Restricted
<b>LaunchDetails</b>	Information required to launch an activity and return the learner to a predefined location.	Optional	0 or 1	Container
Commercial Supporter	The organization providing commercial support for the activity.	Optional	0 or 1	Non-null string
<b>Regulatory Information</b>	Contains elements that describe the relationship of this activity to any regulations.	Optional	0 or 1	Container
<b>Module</b>	This is the sub-element of the Activity element. It contains subelements that further define the activities of a single person. See section Module for more information.	Required	1 or more	Container
<b>PointOfCareLearningData</b>	PointOfCareLearningData contains subelements that document data about a point of care learning activity. PointOfCareLearningData is a sub-element of ActivityReport. See section PointOfCareLearningData more information.	Optional	0 or 1	Container
Results	The individual's results for the overall activity. For example, pass or fail.	Optional	0 or 1	Nonnullstring
Any	The Activity element may contain any elements defined by the organization implementing the schema provided those elements are defined in another namespace.	Optional	0 or more	Any datatype

	This is the preferred method of extension.			
--	--------------------------------------------	--	--	--

**Example 1:**

```
<Activity>
  <ProviderOrganization>
    American Academy of Pediatrics
  </ProviderOrganization>
  <ActivityName>eQIPP</ActivityName>
  <Module>
    <ModuleName>Asthma</ModuleName>
    <Status>Registered</Status>
    <StartDate>2003-27-01</StartDate>
    <DueDate>2004-27-01</DueDate>
  </Module>
</Activity>
```

**Example 2:**

```
<Activity>
  <ProviderOrganization>Nonesuch University</ProviderOrganization>
  <ActivityName>Pain Management Update</ActivityName>
  <ActivityInstanceID
domain="idd:accme.org:instance">12345</ActivityInstanceID>
  <Status>Completed</Status>
  <LaunchDetails>
    <LaunchAction>noaction</LaunchAction>
    <ActivityLocation>http://nonesuch.edu/node123</ActivityLocation>
  </LaunchDetails>
  <CommercialSupporter>REMS Program Companies</CommercialSupporter>
  <RegulatoryInformation>
    <CompliantToRegulation label="Opioid
REMS">http://www.accessdata.fda.gov/drugsatfda_docs/label/2018/OpioidREM20
18.pdf</CompliantToRegulation>
  </RegulatoryInformation>
  <Module>
    <ModuleName>Pain Management Update</ModuleName>
    <Results>Pass</Results>
  </Module>
</Activity>
```

## 10 LaunchDetails

LaunchDetails has subelements that provide information required to launch an activity and return the learner to a predefined location. LaunchDetails is optional.

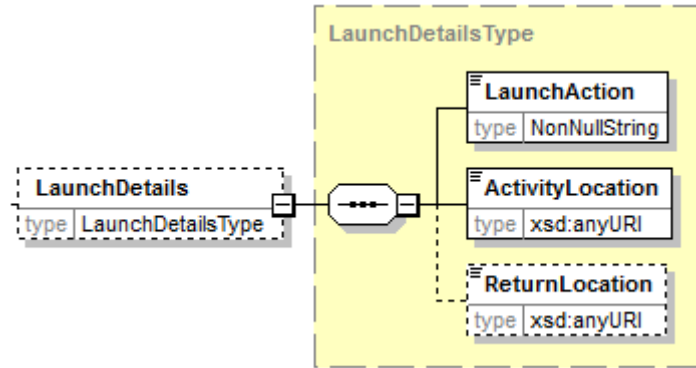

### LaunchDetails Element Information

Element	Description	Required	Multiplicity	Datatype
<b>LaunchDetails</b>	LaunchDetails has subelements that provide information required to launch an activity and return the learner to a predefined location	Optional	0 or 1	Container
LaunchAction	The user's desired action while launching the activity. Recommended values are: Noaction – the user does not require any action to be taken Activity – the user desires to be placed in the activity to start, resume, or review the activity CE – the user desires to either claim CE credit or view the CE certificate or equivalent report for the credit earned. Registry – the user wishes to access the clinical registry associated with this activity	Required	0 or 1	NonNullstring
ActivityLocation	The location to launch this activity. The location may include a token required for access.	Required	0 or 1	anyURI
ReturnLocation	The location to which the learner will return upon exiting the activity.	Optional	0 or 1	anyURI

Example: TBD

## 10.1 RegulatoryInformation

RegulatoryInformation contains elements that describe the relationship of this activity to any regulations.

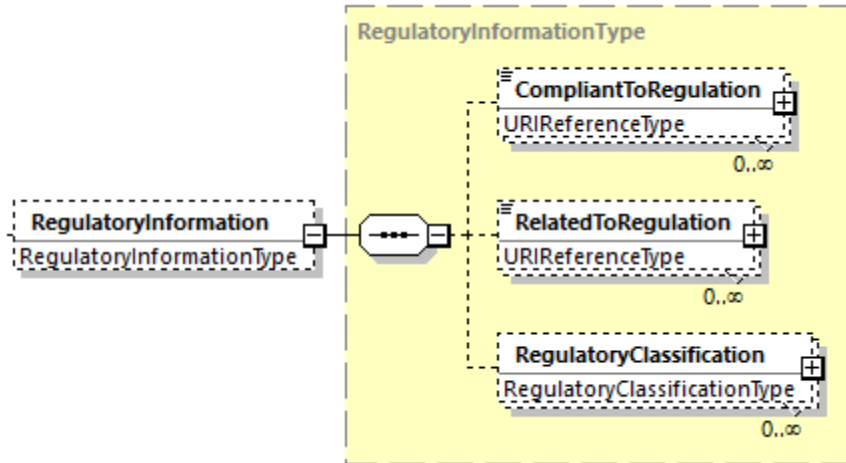

**RegulatoryInformation Element Information**

Element	Description	Required	Multiplicity	Datatype
<b>RegulatoryInformation</b>	Contains elements that describe the relationship of this activity to any regulations.	Optional	0 or 1	<b>Container</b>
CompliantToRegulation	CompliantToRegulation indicates that the activity described is compliant to requirements outlined in a regulation. The value of CompliantToRegulation is the URI of the regulation.  CompliantToRegulation has the following attribute:  <i>label</i> A label for the regulation. For example, ER/LA Opioid REMS.	Optional	0 or more	Any URI

Element	Description	Required	Multiplicity	Datatype
RelatedToRegulation	<p>RelatedToRegulation indicates that the activity described is related to requirements outlined in a regulation. The value of RelatedToRegulation is the URI of the regulation.</p> <p>RelatedToRegulation has the following attribute:</p> <p><i>label</i> A label for the regulation. For example, ER/LA Opioid REMS.</p>	Optional	0 or more	Any URI
<b>RegulatoryClassification</b>	<p>Contains subelements that describe how the activity described relates to a classification system used within the regulation, such as the Blueprint used within a Risk Evaluation and Mitigation Strategy. For more information, see section RegulatoryClassification.</p>	Optional	0 or more	Container

Example:

```

<RegulatoryInformation>
  <CompliantToRegulation label="ER/LA Opioid REMS">
http://www.accessdata.fda.gov/drugsatfda_docs/label/2012/OpioidREMJuly2012.pdf
  </CompliantToRegulation>
</RegulatoryInformation>

```

### 10.1.1 RegulatoryClassification

RegulatoryClassification describes how the activity described relates to a classification system used within the regulation.



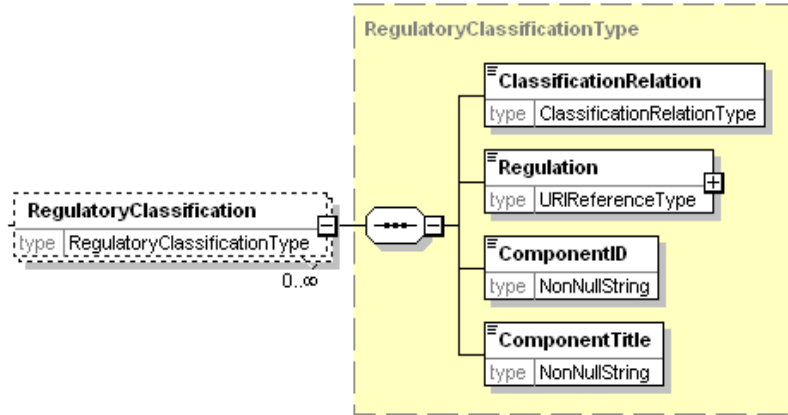

**RegulatoryClassificationElementInformation**

Element	Description	Required	Multiplicity	Datatype
<b>RegulatoryClassification</b>	Contains subelements that describe how the activity described relates to a classification system used within the regulation, such as the Blueprint used within a Risk Evaluation and Mitigation Strategy.	Optional	0 or more	Container
ClassificationRelation	ClassificationRelation describes whether the activity’s post course assessment addresses the regulation component or whether the activity’s instruction addresses the regulation component.  Valid values are Assessment Addresses and Instruction Addresses.	Required	1	Restricted

Element	Description	Required	Multiplicity	Datatype
Regulation	<p>Regulation points to the regulation that contains the classification system used to classify this activity. The value of Regulation is the URI of the regulation.</p> <p>Regulation has the following attribute:</p> <p><i>label</i> A label for the regulation. For example, ER/LA Opioid REMS.</p>	Required	1	Any URI
ComponentID	The identifier for the component of the classification system. For example, II.	Required	1	NonNullString
ComponentTitle	The title for the component of the classification system. For example, Initiating Therapy, Modifying Dosing, and Discontinuing Use of ER/LA Opioid Analgesics.	Required	1	NonNullString

#### Example:

```

<RegulatoryClassification>
  <ClassificationRelation>Instruction Addresses</ClassificationRelation>
  <Regulation label="ER/LA Opioid
REMS">http://www.accessdata.fda.gov/drugsatfda_docs/label/2012/OpioidREMJuly2
012.pdf</Regulation>
  <ComponentID>II</ComponentID>
  <ComponentTitle>Initiating Therapy, Modifying Dosing, and Discontinuing
Use of ER/LA Opioid Analgesics</ComponentTitle>
</RegulatoryClassification>

```

## 11 Module

Module is the subelement of Activity. Module contains subelements that define an educational or other activity and an individual's status in relation to that activity. There may be many Modules within an activity. If the activity does not consist of multiple modules, the module should still be used, and the

ModuleName should be identical to the ActivityName. Module is required and may occur multiple times.

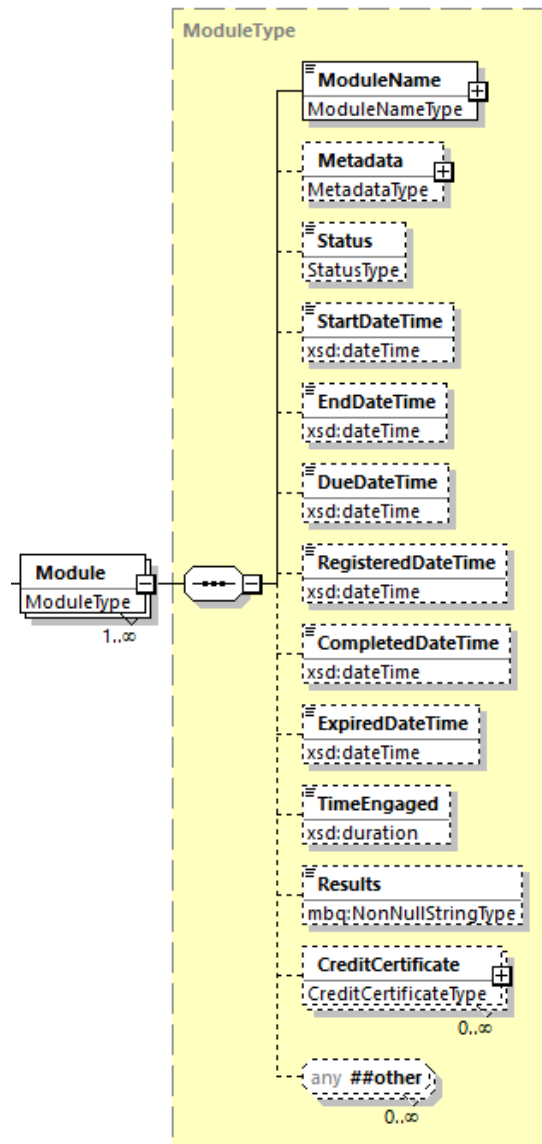

Example:

```
<Module>
  <ModuleName>Preventive Guidelines for Women</ModuleName>
  <Metadata>
    <Location>http://my.americanheart.org/metadata/001.xml</Location>
  </Metadata>
  <Status>Completed</Status>
  <CompletedDateTime>2005-11-09T21:30:00</CompletedDate>
  <TimeEngaged>PT1H30M</TimeEngaged>
  <Results>Pass</Results>
</Module>
```

```

<CreditCertificate>
  <CreditReceived>
    <hx:accreditingBody>ACCME</hx:accreditingBody>
    <hx:activityCertification>
      AMA PRA category 1
    </hx:activityCertification>
    <hx:creditType>CME</hx:creditType>
    <hx:creditUnit>Credits</hx:creditUnit>
    <hx:accreditedProvider>
      American Heart Association
    </hx:accreditedProvider>
    <hx:releaseDate>2005-10-30</hx:releaseDate>
    <hx:expirationDate>2006-10-30</hx:expirationDate>
    <hx:numberOfCredits>1.5</hx:numberOfCredits>
  </CreditReceived>
  <CreditID>ccid:americanheart.org:12345.8767<CreditID>
</CreditCertificate>
</Module>

```

### Module Element Information

Element	Description	Required	Multiplicity	Datatype
<b>Module</b>	Module is the subelement of Activity. It contains subelements that further define the activities of a single person. If the activity described does not include multiple modules, the Module element should still be used to describe the details of the activity.	Required	1 or more	Container
ModuleName	This is a sub-element of the Module element. It defines the name of the module within this activity. For example, if the activity is the Pediatrics eQIPP resource for practice improvement, the module may be Asthma. This element has the following attribute: <i>moduleID</i> A unique identifier for this module.	Required	1	NonNullString

<b>Metadata</b>	This is a sub-element of the Module element. It contains subelements that provide or reference descriptive metadata for the activity.	Optional	0 or 1	Container
Status	This is a sub-element of the Module element. It defines the individual's status in relation to this module. Valid values are registered, completed, and expired.	Optional	1	Restricted
StartDateTime	This is a sub-element of the Module element. It defines the date and time the individual started this module.	Optional	0 or 1	dateTime
EndDateTime	This is a sub-element of the Module element. It defines the date and time that the individual ended the module.	Optional	0 or 1	dateTime
DueDateTime	This is a sub-element of the Module element. It defines the final date and time for this individual to complete this module according to the sending organization. The receiving organization (e.g. the certifying board) may have a different due date for this module if it is required to maintain certification.	Optional	0 or 1	dateTime
RegisteredDateTime	This is a sub-element of the Module element. It defines the date and time the individual registered for this module.	Optional	0 or 1	dateTime
CompletedDateTime	This is a sub-element of the Module element. It defines the date and time the individual completed this module.	Optional	0 or 1	dateTime

ExpiredDateTime	This is a sub-element of the Module element. It defines the date and time the individual's access to the module expired.	Optional	0 or 1	dateTime
TimeEngaged	This is a sub-element of the Module element. It defines the amount of time the participant spent engaged in the activity.	Optional	0 or 1	Duration
Results	This is a sub-element of the Module element. It defines the individual's results for this module. For example, pass or fail.	Optional	0 or 1	NonNullString
<b>CreditCertificate</b>	This is a sub-element of the Module element. It contains subelements that describe and identify the credits received for completing this activity. See section CreditCertificate for more information.	Optional	0 or more	Container
Any	The Module element may contain any elements defined by the organization implementing the schema provided those elements are defined in another namespace. This is the preferred method of extension.	Optional	0 or more	Any datatype

## 11.1 Metadata

Metadata is the subelement of Module. It contains subelements that provide or reference descriptive metadata for the activity.

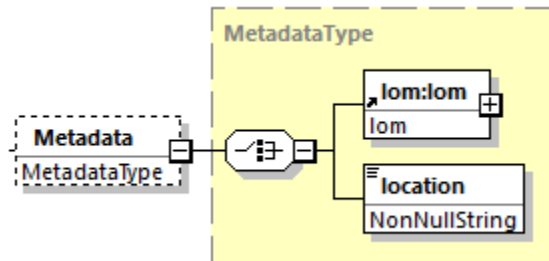

Example:

```

<Metadata>
  <Location> http://www.cd.gov/metadata/001</Location>
</Metadata>
  
```

Or:

```

<Metadata>
  <lom:lom>
    <general>
      <identifier>
        <catalog>URL</catalog>
    </general>
    <entry>http://www.atsdr.cdc.gov/HEC/CSEM/arsenic/index.html</entry>
    </identifier>
    <title>
      <string language="en">Arsenic Toxicity</string>
    </title>
  </lom:lom>
  <metaMetadata>
    <identifier>
      <catalog>URL</catalog>
      <entry>http://www.cd.gov/metadata/001</entry>
    </identifier>
  </metaMetadata>
  <hx:healthcareMetadata>
    <hx:healthcareEducation>
      <hx:expirationDate>2006-10-30</hx:expirationDate>
      <hx:creditsAvailable>yes</hx:creditsAvailable>
    </hx:healthcareEducation>
  </hx:healthcareMetadata>
  
```

```

    <hx:credits>
      <hx:accreditingBody>ACCME</hx:accreditingBody>
      <hx:activityCertification>AMA PRA category
1</hx:activityCertification>
      <hx:creditType>CME</hx:creditType>
      <hx:creditUnit>Credits</hx:creditUnit>
      <hx:accreditedProvider>
        Centers for Disease Control and Prevention
      </hx:accreditedProvider>
      <hx:releaseDate>2005-10-30</hx:releaseDate>
      <hx:expirationDate>2006-10-30</hx:expirationDate>
      <hx:numberOfCredits>1.5</hx:numberOfCredits>
    </hx:credits>
  </hx:healthcareMetadata>
</lom:lom>
</Metadata>

```

### Metadata Element Information

Element	Description	Required	Multiplicity	Datatype
<b>Metadata</b>	This is a sub-element of the Module element. It contains subelements that provide or reference descriptive metadata for the activity.	Optional	0 or 1	Container
<b>lom</b>	This is a sub-element of the Module element. It contains subelements that provide a full learning object metadata record using the Healthcare Learning Object Metadata specification. Metadata provides descriptive information about an activity.	Either lom or Location is required	1	lom See the <i>Healthcare Learning Object Metadata Specifications and Description Document</i> for more information.
Location	This is a sub-element of the Module element. It provides a URL or other location reference for a learning object metadata record that uses the Healthcare Learning Object Metadata specification.	Either lom or Location is required	1	Non-null string

## 11.2 CreditCertificate

CreditCertificate is the subelement of Module. CreditCertificate describes and identifies the credits received for completing an education or certification activity.



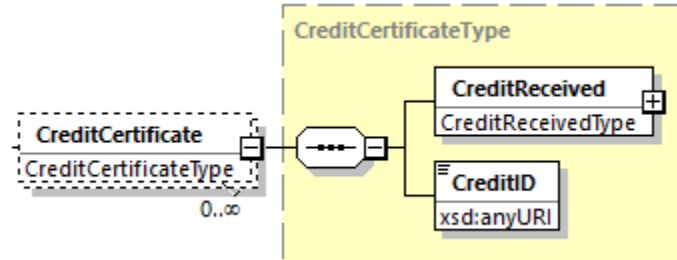

Example:

```

<CreditCertificate>
  <CreditReceived>
    <hx:accreditingBody>ACCME</hx:accreditingBody>
    <hx:activityCertification>
      AAFP Elective
    </hx:activityCertification>
    <hx:creditType>CME</hx:creditType>
    <hx:creditUnit>Credits</hx:creditUnit>
    <hx:accreditedProvider>
      American Academy of Pediatrics
    </hx:accreditedProvider>
    <hx:releaseDate>2006-04-01</hx:releaseDate>
    <hx:expirationDate>2007-04-01</hx:expirationDate>
    <hx:numberOfCredits>3</hx:numberOfCredits>
  </CreditReceived>
  <CreditID>ccid:aap.org:6789012345</CreditID>
</CreditCertificate>
  
```

*CreditCertificate Element Information*

Element	Description	Required	Multiplicity	Datatype
<b>CreditCertificate</b>	This is a sub-element of the Module element. If a learner received multiple types of credit for an activity, repeat the credit certificate element to describe each type of credit received.	Optional	0 or more	Container
<b>CreditReceived</b>	This is a sub-element of the CreditCertificate element. Its type definition extends the credits type from Healthcare Learning Object Metadata. This element is required if the CreditCertificate element is used. It has subelements that define the number of credits (CME, CE, CPE, or other professional credit) that the individual has received as a result of completing this module.	Required	1	Container See the section CreditReceived for more information.
CreditID	CreditID is the subelement of CreditCertificate. This element is required if the CreditCertificate element is used. It provides a globally unique identifier for the specific credits awarded by the provider to the learner. CreditID uses the Credit Certificate Identifier (heid) Uniform Resource Name (URN) format as shown below: <i>ccid:providerdomain:localidentifier</i>  <i>providerdomain</i> is a the domain name that uniquely identifies the provider of the educational activity. <i>localidentifier</i> is a locally unique identifier for the credit certificate created by the provider.	Required	1	Healthcare Education Identifier URN

### 11.3 CreditReceived

CreditReceived is sub-element of the CreditCertificate element. It has subelements that define the number of credits (CME, CE, CPE, or other professional credit) that the individual has received as a result of completing this module.

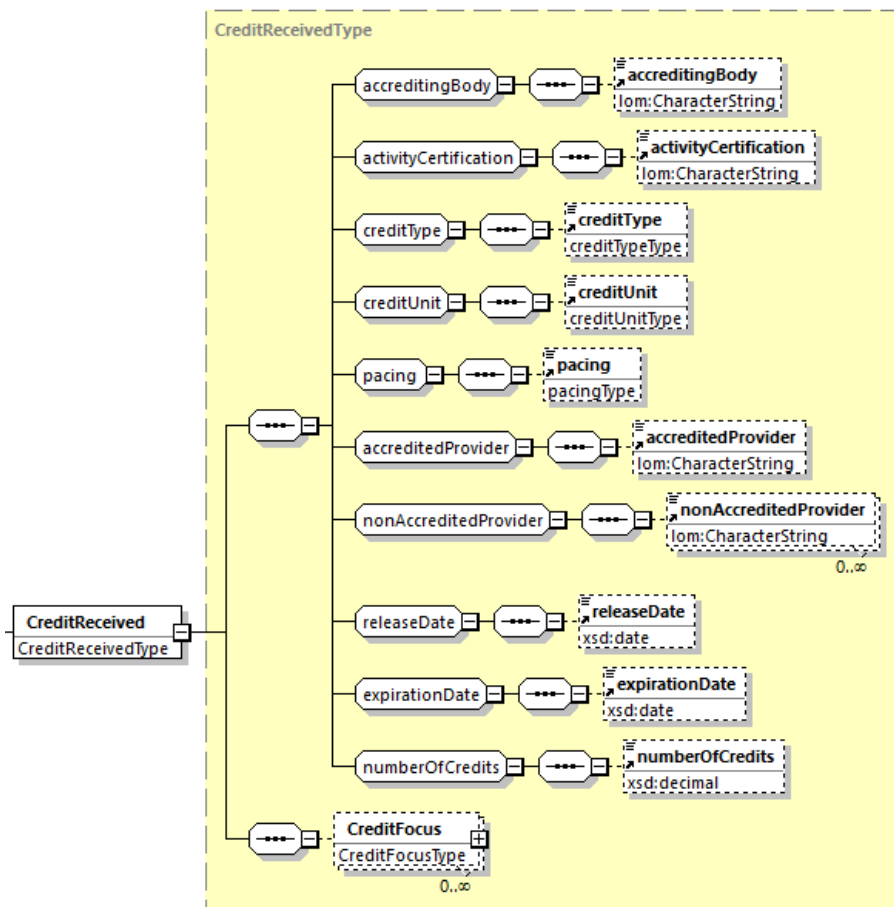

Example:

```

<CreditReceived>
  <hx:accreditingBody>ACCME</hx:accreditingBody>
  <hx:activityCertification>
    AAFP Elective
  </hx:activityCertification>
  <hx:creditType>CME</hx:creditType>
  <hx:creditUnit>Credits</hx:creditUnit>
  <hx:accreditedProvider>

```

```

    American Academy of Pediatrics
  </hx:accreditedProvider>
  <hx:releaseDate>2006-04-01</hx:releaseDate>
  <hx:expirationDate>2007-04-01</hx:expirationDate>
  <hx:numberOfCredits>3</hx:numberOfCredits>
</CreditReceived>

```

**CreditReceived Element Information**

Element	Description	Required	Multiplicity	Datatype
<b>CreditReceived</b>	This is a sub-element of the CreditCertificate element. Its type definition extends the credits type from Healthcare Learning Object Metadata. This element is required if the CreditCertificate element is used. It has subelements that define the number of credits (CME, CE, CPE, or other professional credit) that the individual has received as a result of completing this module.	Required	1	Container
accreditingBody activityCertification creditType creditUnit pacing accreditedProvider nonAccreditedProvider releaseDate expirationDate numberOfCredits	 <p>See the <i>Healthcare Learning Object Metadata Specifications and Description Document</i> description of the credit element for more information.</p>			
<b>CreditFocus</b>	CreditFocus is a subelement of the CreditReceived element. It contains subelements that define a category or area of focus included in this credit certificate. See section CreditFocus for more information.	Optional	0 or more	Container

**11.4 Credit Focus**

CreditFocus defines a category or area of focus included in the credit certificate. Some organizations award subspecialty certificates, others provide categories of credit. CreditFocus enables organizations to describe those category-based credits and certificates.

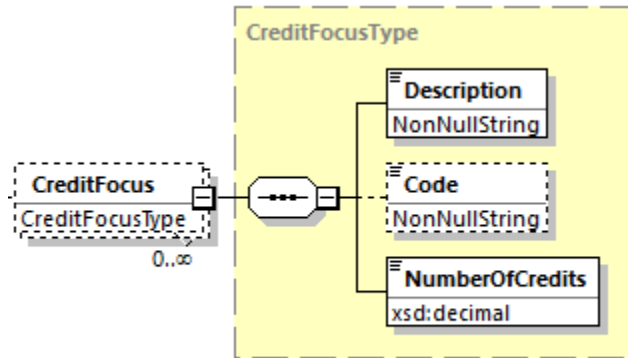

Generated by XMLSpy

www.altova.com

Example:

```
<CreditFocus>
  <Description>CME Computed Tomography</Description>
  <Code>CT</Code>
  <NumberOfCredits>2.5</NumberOfCredits>
</CreditFocus>
```

**CreditFocus Element Description**

Element	Description	Required	Multiplicity	Datatype
<b>CreditFocus</b>	CreditFocus is a subelement of the CreditReceived element. It contains subelements that define a category or area of focus included in this credit certificate.	Optional	0 or more	Container
Description	Description is a subelement of CreditFocus. It provides a text description or category of the credit focus.	Required	1	Non-nullstring
Code	Code is a subelement of CreditFocus that provides a succinct code matching the description.	Optional	0 or 1	Non-nullstring
NumberOfCredits	NumberOfCredits is the subelement of CreditFocus	Required	1	Decimal

	that defines how many credits are associated with this credit focus or category.			
--	----------------------------------------------------------------------------------	--	--	--

## 12 PointOfCareLearning

PointOfCareLearningData contains elements that provide data about a point of care learning experience. PointOfCareLearningData must occur once within a PointOfCareLearningData instance document.

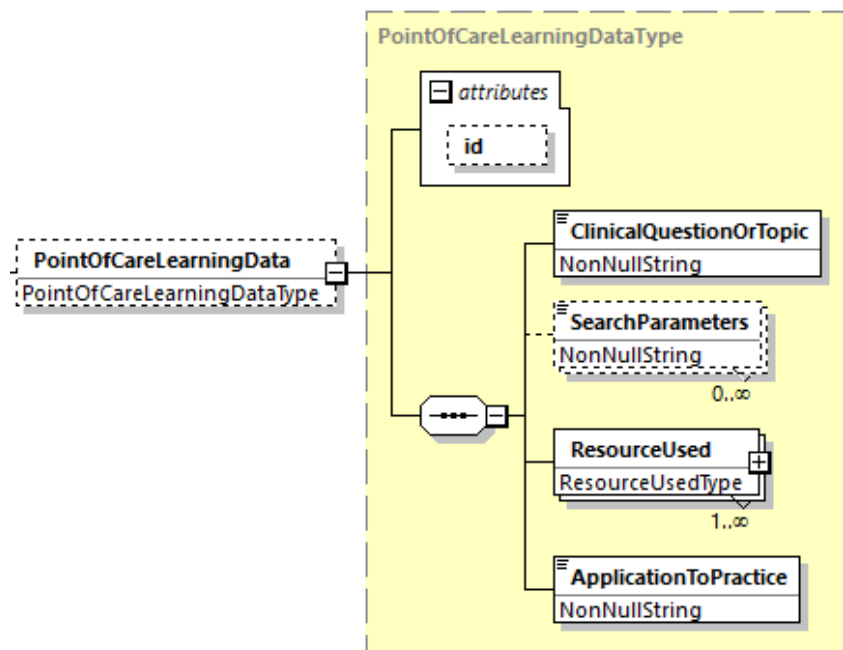

PointOfCareLearningData has the following elements.

### PointOfCareLearningData Element Information

Element	Description	Required	Multiplicity	Datatype
<b>PointOfCareLearningData</b>	PointOfCareLearningData is the root element. It contains elements that provide data about the	Optional	0 or 1	Container

	<p>point-of-care learning experience.</p> <p>PointOfCareLearningData has the following attribute:</p> <p><i>id</i></p> <p>A unique identifier for this set of point of care learning data.</p>			
ClinicalQuestionOrTopic	<p>ClinicalQuestionOrTopic is the subelement of PointOfCareLearningData that describes the clinical question asked or topic selected by the learner to begin the search for learning resources at the point of care.</p>	Required	1	Non-null string
SearchParameters	<p>SearchParameters is the subelement of PointOfCareLearningData that describes the search parameters entered by the learner if a collection search was used to find relevant resources at the point of care.</p>	Optional	0 or more	Non-null string
ResourceUsed	<p>ResourceUsed is the subelement of PointOfCareLearningData that describes the title of a learning resource used as part of this point of care learning experience. If the resource is an article in a collection, use the title of the article. See ResourceUsed section for more information.</p>	Required	1 or more	Container
ApplicationToPractice	<p>ApplicationToPractice is the subelement of PointOfCareLearningData that indicates how the learner describes applying the learning</p>	Required	1	Non-null string

	<p>resource to his or her practice. ApplicationToPractice may indicate that the learner was unable to apply the learning to the question at hand.</p>			
--	-----------------------------------------------------------------------------------------------------------------------------------------------------------	--	--	--

Example:

```

<PointOfCareLearningData>
  <ClinicalQuestionOrTopic>
    Is zinc recommended for type 2 diabetic patients?
  </ClinicalQuestionOrTopic>
  <SearchParameters>zinc</SearchParameters>
  <SearchParameters>diabetes</SearchParameters>
  <ResourceUsed>
    <Title>
      Zinc Supplementation for the Prevention of Type 2 Diabetes Mellitus
    </Title>
    <Collection> The Cochrane Library</Collection>
    <CollectionID type="uri">
      "http://www.cochrane.org/reviews/en/ab005525.html "
    </CollectionID>
    <ResourceLocation>
      "http://www.cochrane.org/reviews/en/ab005525.html "
    </ResourceLocation>
    <Relevant>>true</Relevant>
  </ResourceUsed>
  <ApplicationToPractice>Advised patient that zinc supplementation was not helpful to her condition.</ApplicationToPractice>
</PointOfCareLearningData>

```

## 12.1 ResourceUsed

ResourceUsed contains subelements that describe a resource used as part of this point of care learning activity.



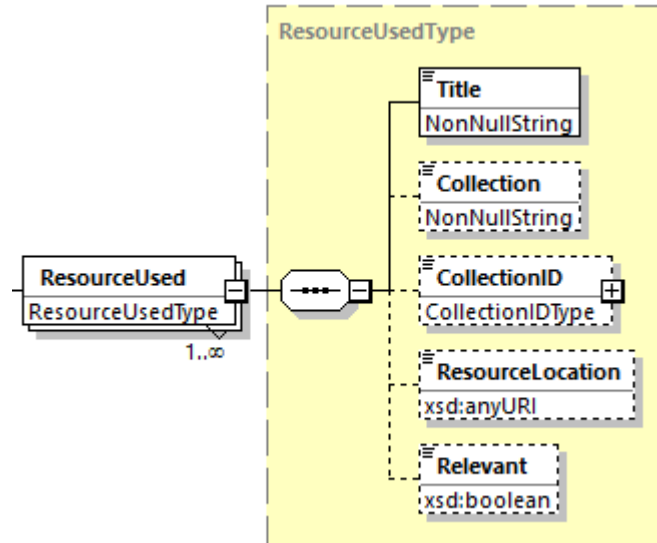

ResourceUsed has the following elements:

#### *ResourceUsed Element Information*

Element	Description	Required	Multiplicity	Datatype
<b>ResourceUsed</b>	ResourceUsed is the subelement of PointOfCareLearningData. It's subelements describe the title and source of a learning resource used as part of this point of care learning experience.	Required	1 or more	Container
Title	Title is the subelement of ResourceUsed that describes the title of a learning resource used as part of this point of care learning experience.	Required	1	Nonnull String
Collection	Collection is the subelement of ResourceUsed that describes the name of the collection that is the source of the article. For example, The Cochrane Library.	Optional	0 or 1	Nonnull String
CollectionID	CollectionID is the subelement of	Optional	0 or 1	Nonnull String

	ResourceUsed that provides the unique identifier of the article used by the collection. If the article has a digital object identifier (DOI), it may be used. CollectionID has one attribute: <i>type</i> the type of identifier used. For example, DOI, PubMed, or URI.			
ResourceLocation	ResourceLocation is the subelement of ResourceUsed that provides the URL of the article.	Optional	0 or 1	URI
Relevant	Relevant is the subelement of ResourceUsed that indicates whether or not the learner found the resource relevant. Valid values are: true, false.	Optional	0 or 1	Restricted

## Example:

```

    <ResourceUsed>
    <Title>
    Zinc Supplementation for the Prevention of Type 2 Diabetes
    Mellitus
    </Title>
    <Collection> The Cochrane Library</Collection>
    <CollectionID type="uri">
    "http://www.cochrane.org/reviews/en/ab005525.html "
    </CollectionID>
    <ResourceLocation>
    "http://www.cochrane.org/reviews/en/ab005525.html "
    </ResourceLocation>
    <Relevant>true</Relevant>
    </ResourceUsed>

```

### 13 XtensibleInfo

The XtensibleInfo element contains sub-elements defined by the organization implementing the schema. XtensibleInfo is included for backward compatibility and is not the preferred method of extension.

XtensibleInfo is a sub-element of ActivityReport.

## 14 Sample XML Documents

### 14.1 CE Credit Example

```
<?xml version = "1.0" encoding = "UTF-8"?>
<ActivityReports xmlns = "http://ns.medbiq.org/activityreport/v1/" xmlns:xsi
= "http://www.w3.org/2001/XMLSchema-instance" xmlns:lom =
"http://ltsc.ieee.org/xsd/LOM" xmlns:m = "http://ns.medbiq.org/member/v1/"
xmlns:n = "http://ns.medbiq.org/name/v1/" xmlns:hx =
"http://ns.medbiq.org/lom/extend/v1/" xsi:schemaLocation =
"http://ns.medbiq.org/activityreport/v1/ activityreport.xsd">
  <DateTimeCreated>2006-04-15T00:00:00</DateTimeCreated>
  <ActivityReport>
    <ReportingOrganization>HighWire Press</ReportingOrganization>
    <Member>
      <m:UniqueID domain = "American Academy of Pediatrics">
        654321
      </m:UniqueID>
      <m:Name>
        <n:GivenName>Paul</n:GivenName>
        <n:GivenName>Lawrence</n:GivenName>
        <n:FamilyName>Dunbar</n:FamilyName>
      </m:Name>
    </Member>
    <Activity>
      <ProviderOrganization>
        American Academy of Pediatrics
      </ProviderOrganization>
      <ActivityName>NeoReviews, Volume 7, Issue 4</ActivityName>
      <Module>
        <ModuleName>NeoReviews, Volume 7, Issue 4</ModuleName>
        <Metadata>
          <location>
            http://neoreviews.aappublications.org/metadata/v7i4.xml
          </location>
        </Metadata>
        <Status>Completed</Status>
        <TimeEngaged>PT3H</TimeEngaged>
        <Results>passed</Results>
        <CreditCertificate>
          <CreditReceived>
            <hx:accreditingBody>ACCME</hx:accreditingBody>
            <hx:activityCertification>
              AAFP Elective
            </hx:activityCertification>
            <hx:creditType>CME</hx:creditType>
            <hx:creditUnit>Credits</hx:creditUnit>
            <hx:accreditedProvider>
              American Academy of Pediatrics
            </hx:accreditedProvider>
            <hx:releaseDate>2006-04-01</hx:releaseDate>
            <hx:expirationDate>2007-04-01</hx:expirationDate>
            <hx:numberOfCredits>3</hx:numberOfCredits>
          </CreditReceived>
        </CreditCertificate>
      </Module>
    </Activity>
  </ActivityReport>
</ActivityReports>
```

```

        <CreditID>ccid:aap.org:6789012345</CreditID>
    </CreditCertificate>
</Module>
</Activity>
</ActivityReport>
</ActivityReports>

```

## 14.2 Opioid REMS Example

```

<?xml version="1.0" encoding="UTF-8"?>
<ActivityReports xmlns="http://ns.medbiq.org/activityreport/v2/"
xmlns:xsi="http://www.w3.org/2001/XMLSchema-instance"
xsi:schemaLocation="http://ns.medbiq.org/activityreport/v2/
activityreport.xsd" arid="arid:nonesuch.edu:D14352">
    <DateTimeCreated>2018-08-28T09:00:00</DateTimeCreated>
    <ReportingStartDate>2018-01-01</ReportingStartDate>
    <ReportingEndDate>2018-06-30</ReportingEndDate>
    <ActivityReport>
        <ReportingOrganization>Nonesuch University</ReportingOrganization>
        <Participants>
            <Participant>
                <LocalIdentifier
domain="idd:nonesuch.edu:ce">H046431</LocalIdentifier>
                <StateOfPrimaryPractice>Michigan</StateOfPrimaryPractice>
                <DEARegistration>Individual</DEARegistration>
                <Profession>Physician</Profession>
                <PracticeArea>General Surgery</PracticeArea>
                <SurgicalProcedures>>true</SurgicalProcedures>
                <TimeInPractice>0-5 years post training</TimeInPractice>
            </Participant>
            <Participant>
                <LocalIdentifier
domain="idd:nonesuch.edu:ce">H025461</LocalIdentifier>
                <StateOfPrimaryPractice>Wisconsin</StateOfPrimaryPractice>
                <DEARegistration>None</DEARegistration>
                <Profession>Nurse</Profession>
                <PracticeArea>Hospice and/or Palliative Care</PracticeArea>
                <SurgicalProcedures>>false</SurgicalProcedures>
                <TimeInPractice>11-15 years</TimeInPractice>
            </Participant>
        </Participants>
        <Activity>
            <ProviderOrganization>Nonesuch University</ProviderOrganization>
            <ActivityName>Pain Management Update</ActivityName>
            <ActivityInstanceID
domain="idd:accme.org:instance">12345</ActivityInstanceID>
            <Status>Completed</Status>

```

```
<LaunchDetails>
  <LaunchAction>noaction</LaunchAction>
  <ActivityLocation>http://nonesuch.edu/node123</ActivityLocation>
</LaunchDetails>
<CommercialSupporter>REMS Program Companies</CommercialSupporter>
<RegulatoryInformation>
  <CompliantToRegulation label="Opioid
REMS">http://www.accessdata.fda.gov/drugsatfda_docs/label/2018/OpioidREM2018.
pdf</CompliantToRegulation>
</RegulatoryInformation>
<Module>
  <ModuleName>Pain Management Update</ModuleName>
  <Results>Pass</Results>
</Module>
</Activity>
</ActivityReport>
</ActivityReports>
```

## 15 References

### Healthcare LOM

ANSI/MEDBIQ LO.10.1-2008, Healthcare Learning Object Metadata (Healthcare LOM). MedBiquitous Website. [http://www.medbiq.org/std\\_specs/standards/index.html#HCLOM](http://www.medbiq.org/std_specs/standards/index.html#HCLOM). Accessed June 1, 2011.

### Professional Profile

ANSI/MEDBIQ PP.10.1-2008, Healthcare Professional Profile. MedBiquitous Website. [http://www.medbiq.org/std\\_specs/standards/index.html#HCProfProfile](http://www.medbiq.org/std_specs/standards/index.html#HCProfProfile) Accessed June 13, 2011.

### XSD

Extensible Markup Language (XML) 1.0 (Fifth Edition), W3C Website. 26 November 2008 <http://www.w3.org/TR/2008/REC-xml-20081126/> . Accessed March 20, 2012.