



Financial Interest Specifications

Version: 0.5

Date: March 28, 2016

Author: Betty Harvey, Eileen

McCoubrey, Valerie Smothers

Author email:

vsmothers@jhmi.edu

Version History

Version No.	Date	Changed By	Changes Made
0.1			Initial draft
0.2	2015-07-20	Valerie Smothers	Licensee now free text or entity reference. The Licensed element may occur multiple times, and it may have multiple licensees. Form of business may occur 0 or more. Form of Compensation may occur 0 to 6 times. Added paymentProcessing attribute to YearlyIncome for different types of Intellectual Property and changed name of element to IPYearlyIncome. Removed the following ContractorCategory values: Speaker training, Board Member, Clinical Oversight Board, Scientific Advisory Board, Product Development, Editorial Service, Contracted, Speakers Bureau, Marketing, Other. Added required id attribute to PersonEntity and OrganizationEntity. Removed OtherContractorCategory. Removed hyphen from schema name in sample xml.
0.3	2015-08-31	Valerie Smothers	Added IPYearlyIncome to Licensee, added Licesee to OtherIntellectualPropertyType, added Description to Trademark, corrected typo in other patent holder. Changes EstimatedValue in Travel to EstimatedOrActualValue.
0.4	2015-10-26	Valerie Smothers	Made license title and date optional, added licenseExists attribute to Licensed, added Licensed to IntellectualPropertyOther, added root element back to schema (was mistakenly erased in previous version).

0.5	2016-03-28	Valerie Smothers	Added Licensed element to Copyright. Added AdditionalInformation to: Employment, IndependentContractor, FifucuaryOfficer, GrantOrContract, Travel, Gift, Stock, StockOptions, OtherSecurities, OtherBusinessOwnership, Patent, Trademark, Copyright, IntellectualpropertyOther. Added support for extensibility to most container elements.
-----	------------	------------------	---

MedBiquitous Consortium XML Public License and Terms of Use

MedBiquitous XML (including schemas, specifications, sample documents, Web services description files, and related items) is provided by the copyright holders under the following license. By obtaining, using, and or copying this work, you (the licensee) agree that you have read, understood, and will comply with the following terms and conditions.

The Consortium hereby grants a perpetual, non-exclusive, non-transferable, license to copy, use, display, perform, modify, make derivative works of, and develop the MedBiquitous XML for any use and without any fee or royalty, provided that you include the following on ALL copies of the MedBiquitous XML or portions thereof, including modifications, that you make.

1. Any pre-existing intellectual property disclaimers, notices, or terms and conditions. If none exist, the following notice should be used: "Copyright © [date of XML release] MedBiquitous Consortium. All Rights Reserved. <http://www.medbiq.org>"
2. Notice of any changes or modification to the MedBiquitous XML files.
3. Notice that any user is bound by the terms of this license and reference to the full text of this license in a location viewable to users of the redistributed or derivative work.

In the event that the licensee modifies any part of the MedBiquitous XML, it will not then represent to the public, through any act or omission, that the resulting modification is an official specification of the MedBiquitous Consortium unless and until such modification is officially adopted.

THE CONSORTIUM MAKES NO WARRANTIES OR REPRESENTATIONS, EXPRESS OR IMPLIED, WITH RESPECT TO ANY COMPUTER CODE, INCLUDING SCHEMAS, SPECIFICATIONS, SAMPLE DOCUMENTS, WEB SERVICES DESCRIPTION FILES, AND RELATED ITEMS. WITHOUT LIMITING THE FOREGOING, THE CONSORTIUM DISCLAIMS ANY IMPLIED WARRANTIES OF MERCHANTABILITY OR FITNESS FOR A PARTICULAR PURPOSE AND ANY WARRANTY, EXPRESS OR IMPLIED, AGAINST INFRINGEMENT BY THE MEDBIQUITOUS XML OF ANY THIRD PARTY PATENTS, TRADEMARKS, COPYRIGHTS OR OTHER RIGHTS. THE LICENSEE AGREES THAT ALL COMPUTER CODES OR RELATED ITEMS PROVIDED SHALL BE ACCEPTED BY LICENSEE "AS IS". THUS, THE ENTIRE RISK OF NON-PERFORMANCE OF THE MEDBIQUITOUS XML RESTS WITH THE LICENSEE WHO SHALL BEAR ALL COSTS OF ANY SERVICE, REPAIR OR CORRECTION.

IN NO EVENT SHALL THE CONSORTIUM OR ITS MEMBERS BE LIABLE TO THE LICENSEE OR ANY OTHER USER FOR DAMAGES OF ANY NATURE, INCLUDING, WITHOUT LIMITATION, ANY GENERAL, DIRECT, INDIRECT, INCIDENTAL, CONSEQUENTIAL, OR SPECIAL DAMAGES, INCLUDING LOST PROFITS, ARISING OUT OF ANY USE OF MEDBIQUITOUS XML.

LICENSEE SHALL INDEMNIFY THE CONSORTIUM AND EACH OF ITS MEMBERS FROM ANY LOSS, CLAIM, DAMAGE OR LIABILITY (INCLUDING, WITHOUT LIMITATION, PAYMENT OF ATTORNEYS' FEES AND COURT

COSTS) ARISING OUT OF MODIFICATION OR USE OF THE MEDBIQUITOUS XML OR ANY RELATED CONTENT OR MATERIAL BY LICENSEE.

LICENSEE SHALL NOT OBTAIN OR ATTEMPT TO OBTAIN ANY PATENTS, COPYRIGHTS OR OTHER PROPRIETARY RIGHTS WITH RESPECT TO THE MEDBIQUITOUS XML.

THIS LICENSE SHALL TERMINATE AUTOMATICALLY IF LICENSEE VIOLATES ANY OF ITS TERMS AND CONDITIONS.

The name and trademarks of the MedBiquitous Consortium and its members may NOT be used in advertising or publicity pertaining to MedBiquitous XML without specific, prior written permission. Title to copyright in MedBiquitous XML and any associated documentation will at all times remain with the copyright holders.

Table of Contents

1	Acknowledgements.....	8
2	Documentation Conventions	10
3	Conformance.....	11
4	Common Data Types.....	12
4.1	Common Components	12
4.1.1	Name.....	12
4.1.2	Address.....	13
4.1.3	AverageHours.....	14
4.1.4	ActivityDateSpan.....	15
4.1.5	DateSpan	15
4.1.6	Licensed.....	16
4.1.7	Licensee.....	17
5	Common Attributes	19
5.1	<i>financialInterestExists</i>	19
6	Introduction	21
7	Other Standards, Specifications, or Schemas Referenced.....	22
7.1	Other Schema Referenced.....	22
8	Financial Interest Schema	23
8.1	FinancialInterestPackages.....	24
8.2	IndividualFinancialInterestPackage	27
8.3	Metadata.....	29
8.3.1	CreationInfo	31
8.3.2	UpdateInfo	32
8.4	DisclosingIndividual.....	34
8.5	FinancialDisclosureInformation	36
8.6	FinancialRelationshipEntity.....	41
8.6.1	PersonEntity.....	43
8.6.2	OrganizationEntity	46
8.7	ProfessionalServices.....	51

8.7.1	Employment.....	54
8.7.2	IndependentContractor	57
8.7.3	FiduciaryOfficer.....	61
8.8	FinancialSupport	64
8.8.1	GrantOrContract	67
8.8.2	Travel.....	71
8.8.3	Gift.....	73
8.9	FinancialStake	75
8.9.1	Stock.....	79
8.9.2	StockOptions.....	81
8.9.3	OtherSecurities	82
8.9.4	OtherBusinessOwnership.....	86
8.10	IntellectualProperty	90
8.10.1	Patent.....	93
8.10.2	Trademark.....	96
8.10.3	Copyright.....	99
8.10.4	IntellectualPropertyOther.....	101
8.10.5	IPYearlyIncome	104
9	Sample XML Document.....	107
10	References	126

1 Acknowledgements

The development of this specification is made possible as part of an accelerated standards development project funded by the Association of American Medical Colleges.

The MedBiquitous Consortium wishes to acknowledge the MedBiquitous Financial Interest Working Group members, invited experts, and other individuals that contributed to the creation of this document.

Co-chairs

- David Blake, Cedars-Sinai
- Ross McKinney, Duke University

Members

- Panos Bamidis, Aristotle University
- Luke Diorio, Association of American Medical Colleges
- Julie Gottlieb, Johns Hopkins University
- Shilpi Gupta, Association of American Medical Colleges
- Raymond Hutchinson, University of Michigan
- Kirke Lawton, Association of American Medical Colleges
- Heather Pierce, Association of American Medical Colleges
- Kelly Reddick, American Board of Pediatrics
- Radu Vestemean, Knowledge4You
- Dongming Zhang, American Board of Pediatrics

Invited Experts

- Marie Beaulier, MMIS, Inc.
- Elizabeth Boyd, University of California, Riverside
- Mike Champa, Huron Consulting
- Susan Chimonas, Columbia University
- Michaeline Daboul, MMIS, Inc.
- Josh Dahl, Thomson Reuters
- Raed Dweik, Cleveland Clinic
- Susan Ehringhaus, Partners HealthCare
- Betty Harvey, Electronic Commerce Connection, Inc.
- Norman Kahn, Council of Medical Specialty Societies
- Allen Lichter, American Society of Clinical Oncology
- Nancy Lowitt, University of Maryland School of Medicine
- Monika Markowitz, Virginia Commonwealth University
- Patrick McCormick, Neurosurgical Network, Inc.

- Raj Mehrotra, HCCS
- Pamela Miller, New England Journal of Medicine
- Lisa Oliff, American Society of Clinical Oncology
- Tim Robinson, MMIS, Inc.
- Bill Sacks, HCCS
- Cory Schmidt, Cleveland Clinic
- Steve Singer, ACCME
- Rebecca Spence, American Society of Clinical Oncology
- John Sweeney, ACCME
- Gary Wimsett, University of Florida

2 Documentation Conventions

This document uses the following conventions:

Convention	Description
Bold Text	When used with an XML element name, indicates that the element contains sub-elements.
<i>Italics</i>	When used in an XML element description, an attribute of the XML element.
Monospaced type	Sample XML tags, code, schema, or portion thereof.

The document uses graphics generated by Altova XML Spy® software, which uses the following graphical conventions.

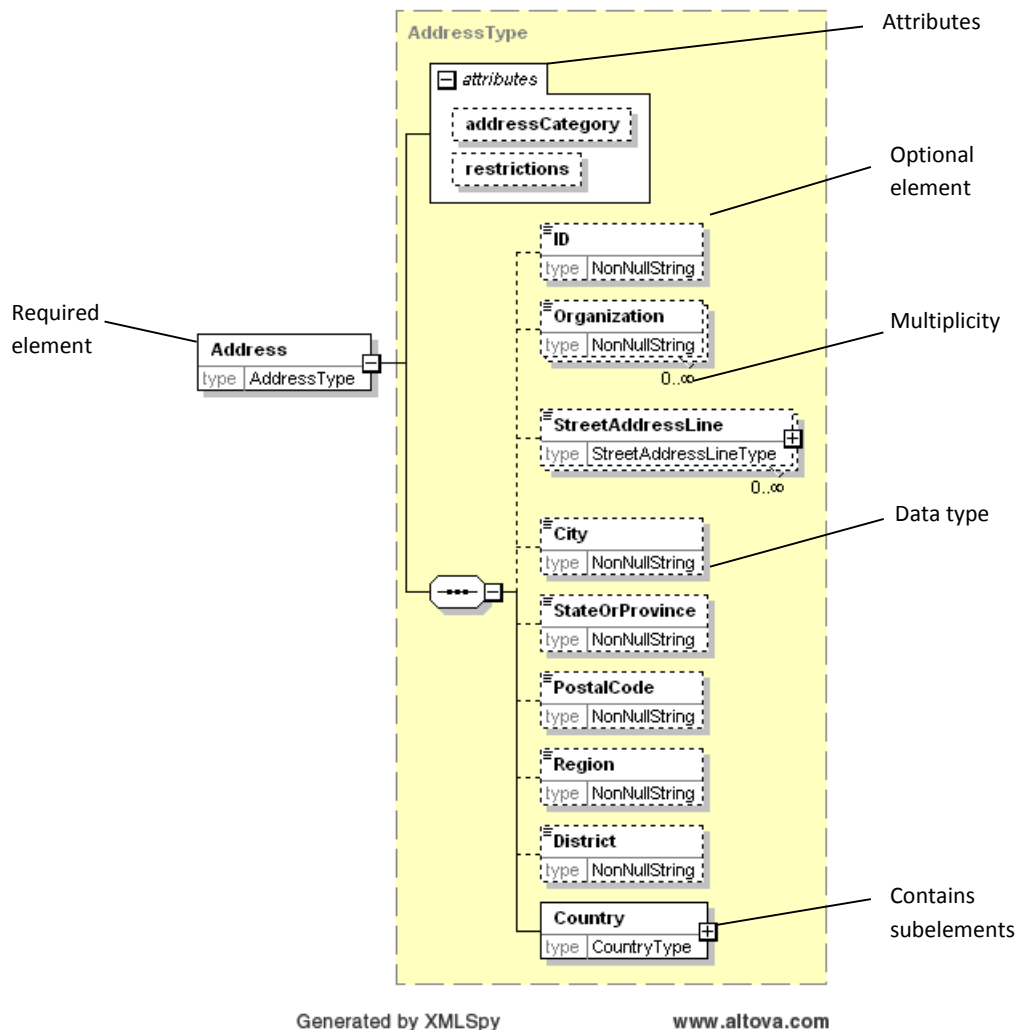

3 Conformance

To conform to the Financial Interest specification, an XML document:

- Shall be valid according to the Financial Interest schema available at:
<http://ns.medbiq.org/financialinterest/v1/financialinterest.xsd>
- Conform to any additional requirements stated in this specification.
- Optionally include elements not defined in this document only in permitted areas and only if those elements are namespace qualified.

4 Common Data Types

Most of the elements and attributes in MedBiquitous XML documents use the data types defined by the W3C XML schema definition. In some cases MedBiquitous creates its own datatypes as part of its best practices or to meet a specific requirement. Commonly used datatypes are described below.

Non-null string

Non-null string is a datatype derived from the XML string datatype. Non-null string imposes a minimum length of one character on a string and ensures that required elements are complete.

4.1 Common Components

Several container elements are used throughout the Financial Interest data model. These components are:

- Name
- Address
- AverageHours
- ActivityDateSpan
- DateSpan
- Licensed

4.1.1 Name

Name contains sub-elements that define a person's name in detail. Name uses the NameType from the MedBiquitous Healthcare Professional Profile. For more information, see ANSI /MEDBIQ PP.10.1-2008 Name Specifications and Description Document [[Name](#)].

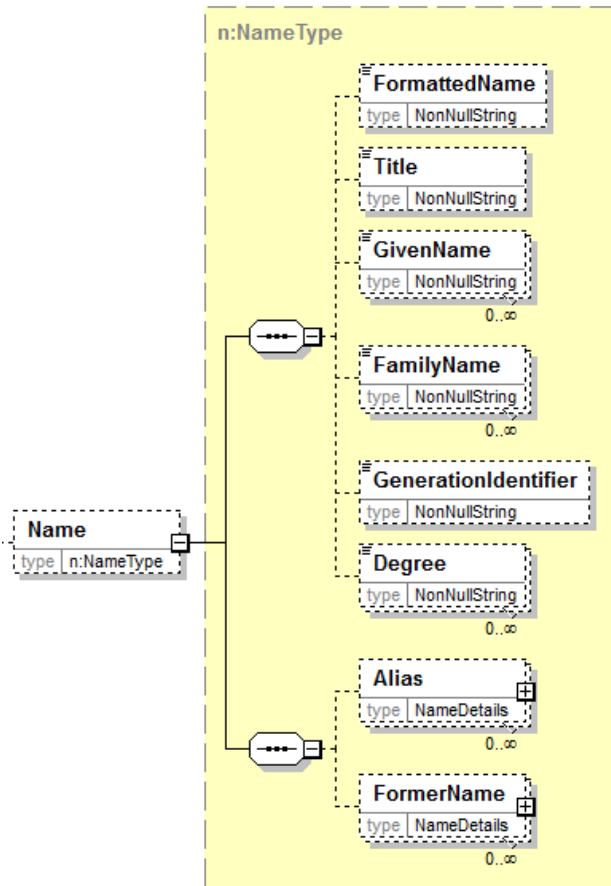

4.1.2 Address

Address contains sub-elements that define a postal address in detail. Address uses the AddressType from the MedBiquitous Healthcare Professional Profile. For more information, see ANSI /MEDBIQ PP.10.1-2008 Address Specifications and Description Document [[Address](#)].

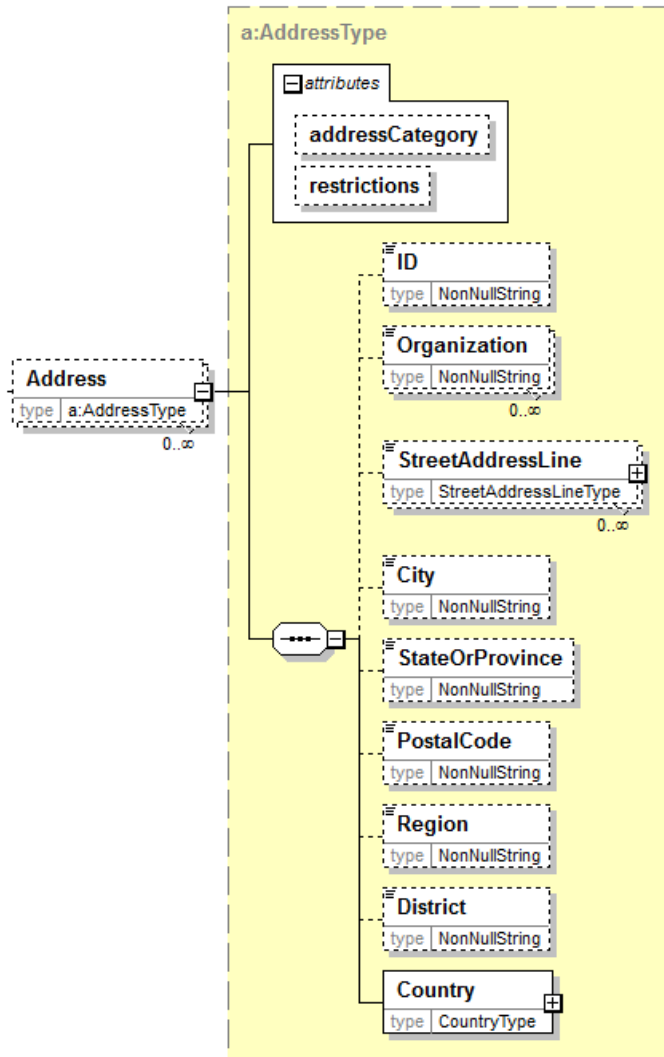

4.1.3 AverageHours

AverageHours identifies average hours worked by an individual.

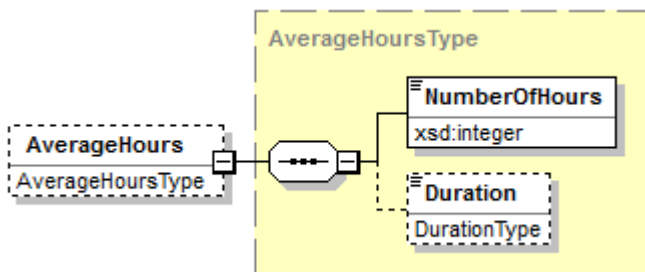

AverageHours Information

Element	Description	Required	Multiplicity	Datatype
AverageHours	The average hours an individual works in a week, month or year.	Optional	0 to 1	Container
NumberOfHours	The average number of hours an individual works for the given duration.	Required	1 to 1	Number
Duration	The duration of the hours reported. Allowed Values: Week Month Year	Optional	0 to 1	Restricted

4.1.4 ActivityDateSpan

ActivityDateSpan is the date with a “begin” and optional “end” date.

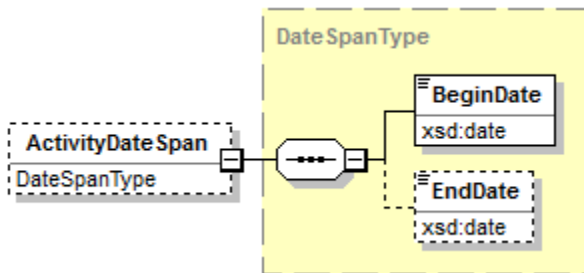

ActivityDateSpan Information

Element	Description	Required	Multiplicity	Datatype
ActivityDateSpan	The date of the activity span with a “begin” and optional “end” date.	Optional	0 to 1	Container
BeginDate	The beginning date.	Required	1 to 1	Date
EndDate	The end date of the activity. If the end date is absent, the activity is considered ongoing.	Optional	0 to 1	Date

4.1.5 DateSpan

DateSpan identifies a “begin” and optional “end” date.

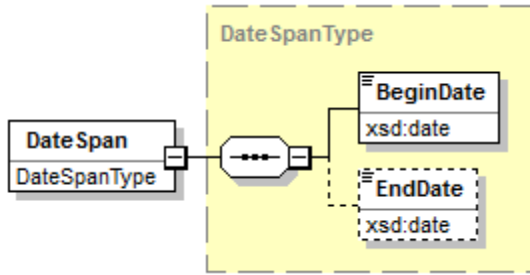

DateSpan Information

Element	Description	Required	Multiplicity	Datatype
DateSpan	A date span with a “begin” and optional “end” date.	Required	1 to 1	Container
BeginDate	The beginning date.	Required	1 to 1	Date
EndDate	The end date of the activity. If the end date is absent, the activity is considered ongoing.	Optional	0 to 1	Date

4.1.6 Licensed

Licensed describes licensing of the intellectual property.

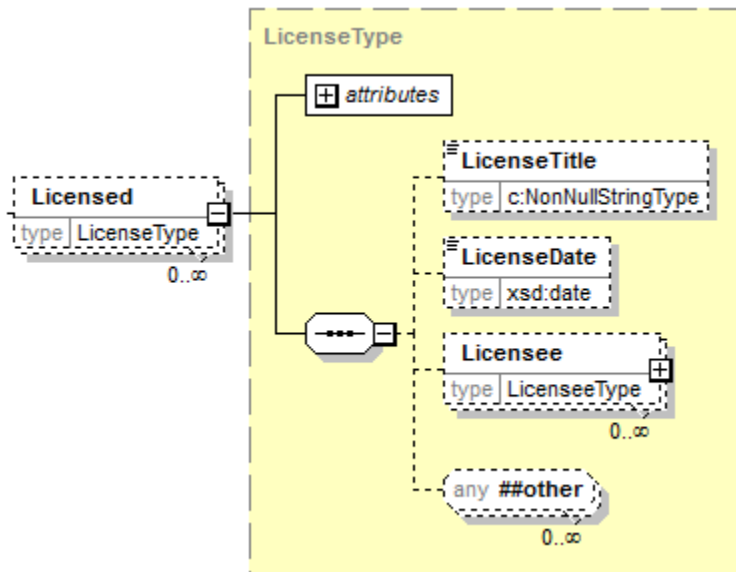

Licensed Information

Element	Description	Required	Multiplicity	Datatype
Licensed	Contains sub-elements that describe licensing of the intellectual property. Attributes: <i>licenseExists</i> — The 'licenseExists' attribute can be used to show the existence of a license. This attribute is optional and should be used when further information isn't required by the organization.	Optional	0 or more	Container
LicenseTitle	The name or type of the license.	Optional	0 to 1	Non-null string
LicenseDate	The license start date	Optional	0 to 1	Date
Licensee	Contains sub-elements that describe the licensee of the intellectual property. See section Licensee for more information.	Optional	0 or more	Container
Any	Any elements defined by the organization implementing the schema provided those elements are defined in another namespace.	Optional	0 or more	Any datatype

4.1.7 Licensee

Licensee describes the licensee of the intellectual property.

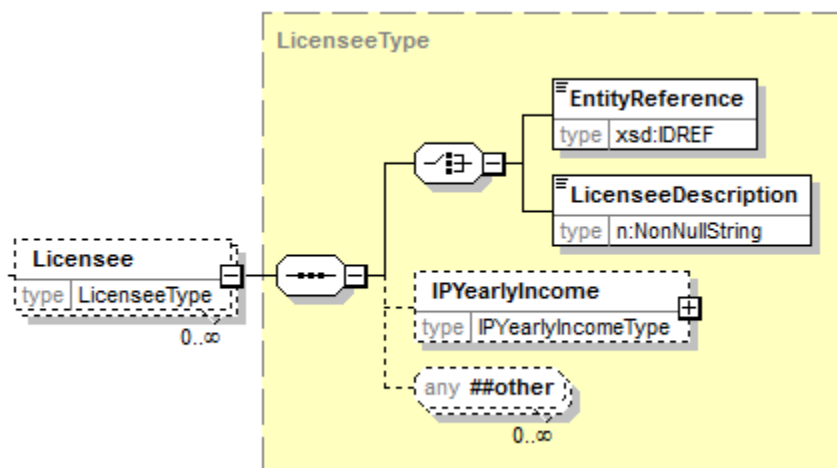

Licensee Information

Element	Description	Required	Multiplicity	Datatype
Licensee	Contains sub-elements that describe the licensee of the intellectual property.	Optional	0 or more	Container
EntityReference	A reference to a defined OrganizationEntity or PersonEntity.	Required	1 to 1	IDREF
LicenseeDescription	The license start date	Required	1 to 1	Non-null string
IPYearlyIncome	Contains subelements that describe the yearly income from this licensee and how the payment to the disclosing individual was processed. For more information, see section IPYearlyIncome.	Optional	0 to 1	Container
Any	Any elements defined by the organization implementing the schema provided those elements are defined in another namespace.	Optional	0 or more	Any datatype

5 Common Attributes

MedBiquitous has defined common attributes that are applied to the following elements:

FinancialInterestPackages, IndividualFinancialInterestPackage, and FinancialDisclosureInformation.

Use of these attributes is optional.

Attribute	Description	Multiplicity	Datatype
id	A unique identifier for this piece of data. The identifier must be unique within the scope of the Healthcare Professional document.	0 or 1	ID
validityDate	The date in this piece of data was deemed valid. For example, the date of entry.	0 or 1	Date
restrictions	Indicates whether this piece of information is to be restricted or confidential when sharing information with partner organizations or the general public. Valid values are: Unrestricted, Restricted, Confidential. Unrestricted indicates that a piece of data may be shared or published. Restricted indicates that a piece of data may be shared in some instances, but not published. Policies must be defined surrounding the use of restricted data. Confidential indicates that a piece of data may not be shared or published.	0 or 1	Restricted
source	The source of this piece of data.	0 or 1	String

5.1 *financialInterestExists*

The financialInterestExists attribute can be used to show the existence of a financial interest.

Attribute	Description	Multiplicity	Datatype
financialInterestExists	The 'financialInterestExists' attribute can be used to show the existence of a financial interest. This attribute is optional and should be used when further information isn't required by the organization.	0 or 1	Boolean

financialinterestExists is an attribute that applies to the following elements.

- Copyright
- Employment
- FiduciaryOfficer
- Gift
- GrantOrContract
- IndependentContractor
- IntellectualPropertyOther
- OtherBusinessOwnership
- OtherSecurities
- Patent
- StockOptions
- Stock
- Trademark
- Travel

6 Introduction

This document describes the MedBiquitous Financial Interest XML Schema in detail. It is intended for use by anyone who wants to create, implement, or create interoperable tools for XML financial disclosures based on this specification. The status of the document is indicated at the bottom of the page; draft documents are subject to review and approval through the MedBiquitous Standards Program Operating Procedures (see http://medbig.org/std_specs/devprocess/MedBiquitousANSIProcess.pdf).

The objective of this Financial Interest Schema is to provide a data structure that allows one to represent one or more organizations to exchange financial disclosure information in a standard format.

The relationships between health professions educators, researchers, and industry are complex. Journals, continuing education providers, schools, societies, teaching hospitals and government agencies often require that authors and faculty disclose their financial interests and other relevant commitments or relationships. Many then work to manage any conflicts. A technical standard will allow institutions to streamline the reporting of financial interests and other disclosure requirements by using a centralized system for collecting data on financial interest and other required disclosures. Such a system could also improve the accuracy and clarity of information reported by ensuring the consistency of data definitions used among organizations.

7 Other Standards, Specifications, or Schemas Referenced

7.1 Other Schema Referenced

This standard references the following standards, specifications, or schemas. The informative references here, which describe how these references are used, link to formal references appearing later in this document.

- ANSI/MEDBIQ PP.10.1-2008, Address [[Address](#)]
The Address specification provides a common format for addresses.
- ANSI/MEDBIQ PP.10.1-2008, Name [[Name](#)]
The Name specification provides a common format for people's names.
- ANSI/MEDBIQ PP.10.1-2008, Healthcare Professional Profile [[Professional Profile](#)]
The Professional Profile provides a common format for describing the unique id, email address, and contact numbers.
- MedBiquitous Common Specifications [[Common](#)]
The MedBiquitous Common Specification defines datatypes commonly used across MedBiquitous specifications.

8 Financial Interest Schema

The following sections explain the Financial Interest Schema grammar. Values in **bold** under XML Tags column indicate that the element has sub-elements.

All the elements having sub-elements will be defined in separate sections. All elements without sub-elements will be defined within the appropriate element sections that use them.

8.1 FinancialInterestPackages

FinancialInterestPackages is information about the financial interests of several individuals.

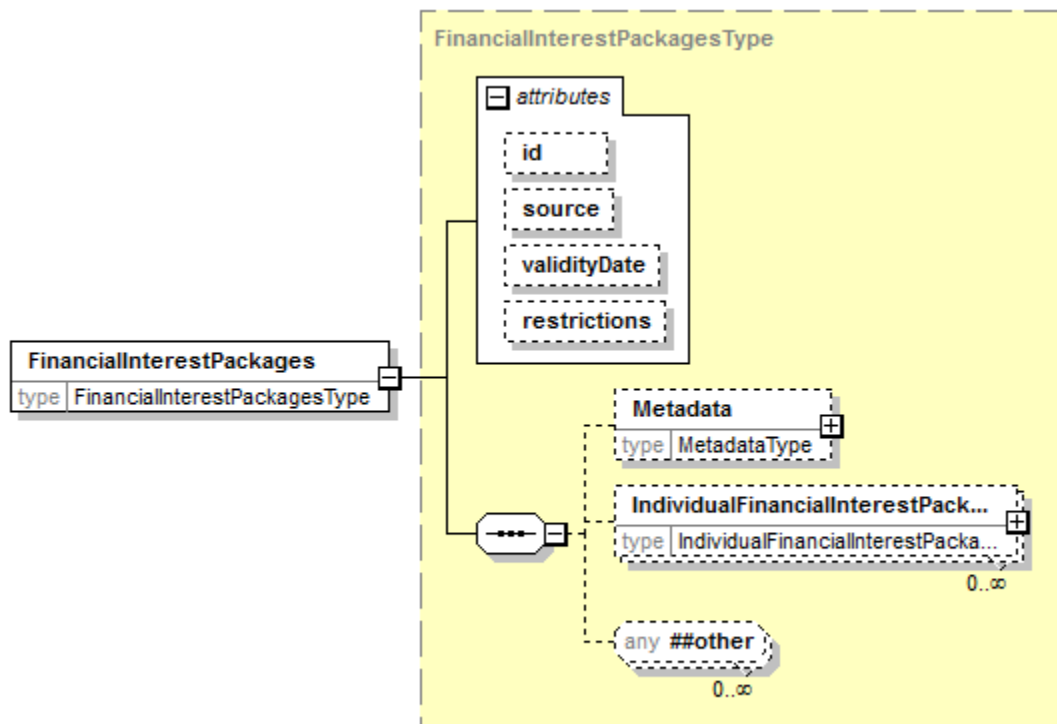

Generated by XMLSpy

www.altova.com

Element	Description	Required	Multiplicity	Datatype
FinancialInterestPackages	This element is the root element. It is a container for multiple individual packages. This data element is used for batch processing.	Optional	0 to more	Container
Metadata	Information about the creation, update, and disclosure profile for a set of information. For more information, see section Metadata.	Optional	0 to 1	Container
IndividualFinancialInterestPackage	Information about the financial interests of an individual. For more information, see section IndividualFinancialInterestPackage.	Optional	0 to more	Container
Any	Any elements defined by the organization implementing the schema provided those elements are defined in another namespace.	Optional	0 or more	Any datatype

Example:

```

<IndividualFinancialInterestPackage id="Package1">
  <Metadata>
    <DisclosureProfile>NEJM Manuscript Submission</DisclosureProfile>
    <CreationInfo>
      <CreationDateTime>2015-02-24T17:43:00</CreationDateTime>
      <UniqueID domain="aamc">aamc1234</UniqueID>
    </CreationInfo>
    <UpdateInfo>
      <UpdateDateTime>2015-02-28T12:19:00</UpdateDateTime>
      <UniqueID domain="aamc">aamc1234</UniqueID>
    </UpdateInfo>
  </Metadata>
  <DisclosingIndividual>
    ...
  </DisclosingIndividual>

```

```
<FinancialDisclosureInformation id="Employment">
  ...
</FinancialDisclosureInformation>
</IndividualFinancialInterestPackage>
```

8.2 IndividualFinancialInterestPackage

IndividualFinancialInterestPackage provides information of an individual’s financial interests.

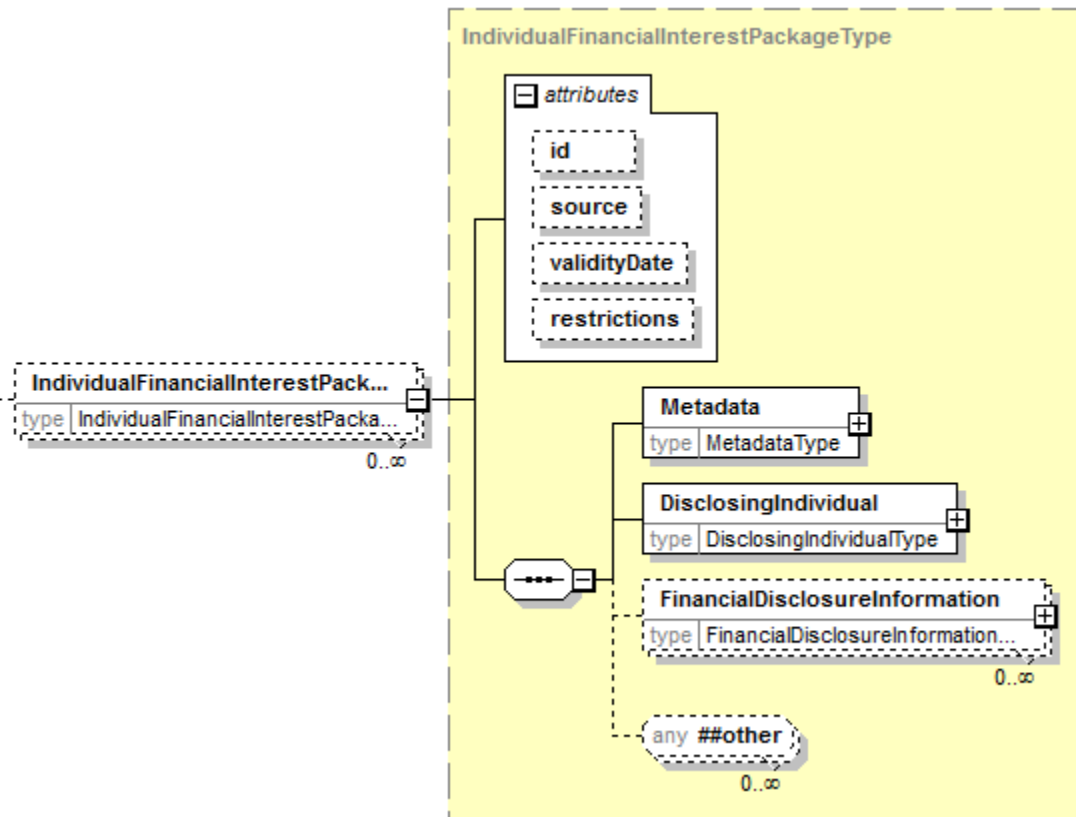

IndividualFinancialInterestPackage Information

Element	Description	Required	Multiplicity	Datatype
IndividualFinancialInterestPackage	Information about the financial interests of an individual.	Optional	0 to more	Container
Metadata	Information about the creation, update, and disclosure profile for a set of information. For more information, see section Metadata.	Required	1 to 1	Container
DisclosingIndividual	The individual who is disclosing financial interests. For more information, see section Disclosing Individual.	Required	1 to 1	Container
FinancialDisclosureInformation	Information regarding a set of financial interests with a particular company or in regards to intellectual property. For more information, see section FinancialDisclosureInformation.	Optional	0 to more	Container
Any	Any elements defined by the organization implementing the schema provided those elements are defined in another namespace.	Optional	0 or more	Any datatype

Example:

```

<IndividualFinancialInterestPackage id="Package2">
  <Metadata>
    <CreationInfo>
      <CreationDateTime>2015-04-15T15:20:01</CreationDateTime>
      <UniqueID domain="AAMC">Smith.John</UniqueID>
    </CreationInfo>
  </Metadata>
  <DisclosingIndividual>
    ...
  </DisclosingIndividual>
  <FinancialDisclosureInformation id="EmptyContent">
    ...
  </FinancialDisclosureInformation>
</IndividualFinancialInterestPackage>

```

8.3 Metadata

Metadata contains information about the creation, update, and disclosure profile for a set of information.

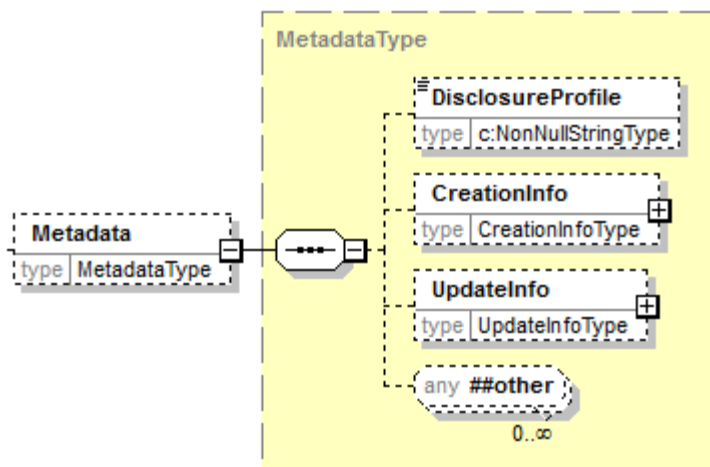

Metadata Information

Element	Description	Required	Multiplicity	Datatype
Metadata	Information about the creation, update, and disclosure profile for a set of information	Optional	0 to 1	Container
DisclosureProfile	A label for the profile used to create the disclosure or disclosure package. For example, NEJM Manuscript Submission.	Optional	0 to 1	Non-null string
CreationInfo	Information on the creator for a set of information as well as the date and time the information was	Optional	0 to 1	Container

Element	Description	Required	Multiplicity	Datatype
	created. For more information, see section CreationInfo.			
UpdateInfo	Information on the individual who updated a set of information as well as the date and time the information was updated. For more information, see section UpdateInfo.	Optional	0 to 1	Container
Any	Any elements defined by the organization implementing the schema provided those elements are defined in another namespace.	Optional	0 or more	Any datatype

Example:

```

<Metadata>
  <DisclosureProfile>NEJM Manuscript Submission</DisclosureProfile>
  <CreationInfo>
    <CreationDateTime>2015-02-24T17:43:00</CreationDateTime>
    <UniqueID domain="aamc">aamc1234</UniqueID>
  </CreationInfo>
  <UpdateInfo>
    <UpdateDateTime>2015-02-28T12:19:00</UpdateDateTime>
    <UniqueID domain="aamc">aamc1234</UniqueID>
  </UpdateInfo>
</Metadata>

```

8.3.1 CreationInfo

CreationInfo describes a set of information including date and time when information was created.

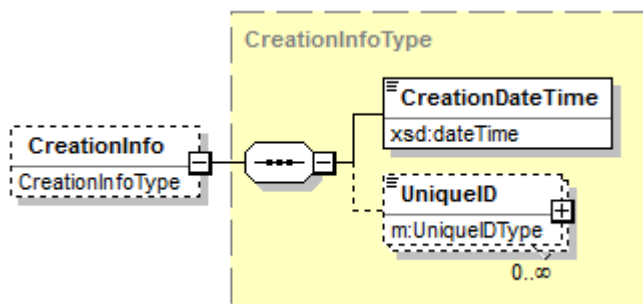

CreationInfo Information

Element	Description	Required	Multiplicity	Datatype
CreationInfo	Information on the creator for a set of information as well as the date and time the information was created.	Optional	0 to 1	Container
CreationDateTime	A date and timestamp indicating when the data component was created.	Required	1 to 1	xsd:dateTime
UniqueID	The identification of the entity (owner, designee or organization) creating the data. UniqueID uses the UniqueIDType from the MedBiquitous Healthcare Professional Profile.	Optional	0 to more	For more information, see ANSI/MEDBIQ 10.1-2008 Healthcare Professional Profile [Professional Profile] .

Example:

```
<CreationInfo>
  <CreationDateTime>2015-02-24T17:43:00</CreationDateTime>
  <UniqueID domain="aamc">aamc1234</UniqueID>
</CreationInfo>
```

8.3.2 UpdateInfo

UpdateInfo identifies individual who updated a set of information.

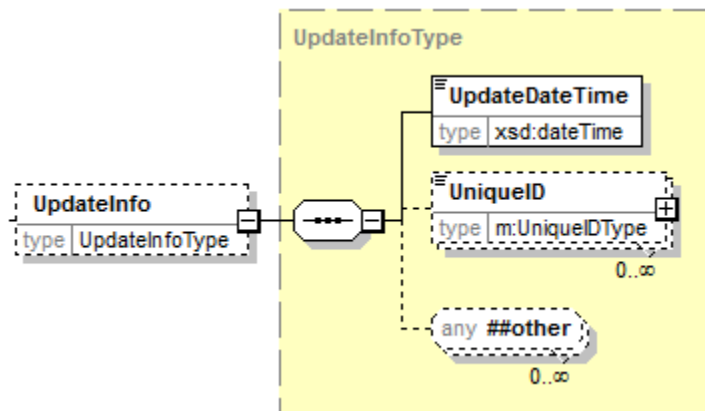

UpdateInfo Information

Element	Description	Required	Multiplicity	Datatype
UpdateInfo	Information on the individual who updated a set of information as well as the date and time the information was updated.	Optional	0 to 1	Container
UpdateDateTime	A date and timestamp indicating when the data component was modified.	Required	1 to 1	xsd:dateTime
UniqueID	The identification of the entity (owner, designee or organization) updating the data. UniqueID uses the UniqueIDType from the MedBiquitous Healthcare Professional Profile.	Optional	0 to more	For more information, see ANSI/MEDBIQ 10.1-2008 Healthcare Professional Profile [Professional Profile] .

Any	Any elements defined by the organization implementing the schema provided those elements are defined in another namespace.	Optional	0 or more	Any datatype
-----	--	----------	-----------	--------------

Example:

```
<Metadata>
  <DisclosureProfile>NEJM Manuscript Submission</DisclosureProfile>
  <CreationInfo>
    <CreationDateTime>2015-02-24T17:43:00</CreationDateTime>
    <UniqueID domain="aamc">aamc1234</UniqueID>
  </CreationInfo>
  <UpdateInfo>
    <UpdateDateTime>2015-02-28T12:19:00</UpdateDateTime>
    <UniqueID domain="aamc">aamc1234</UniqueID>
  </UpdateInfo>
</Metadata>
```

8.4 DisclosingIndividual

DisclosingIndividual identifies the individual who is disclosing financial interests.

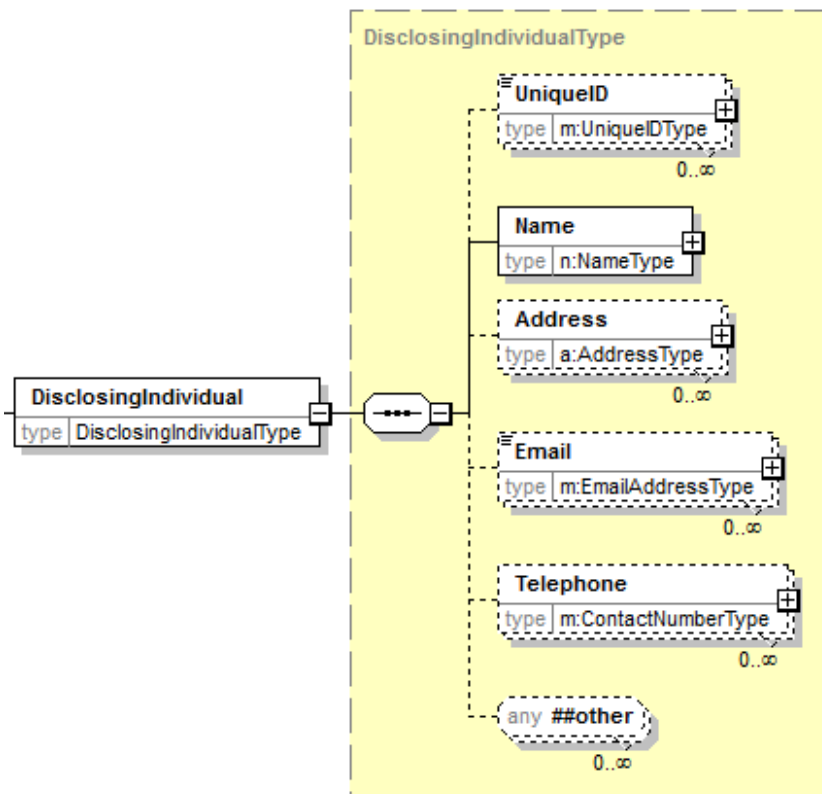

DisclosingIndividual Information

Element	Description	Required	Multiplicity	Datatype
DisclosingIndividual	The individual who is disclosing financial interests.	Required	1 to 1	Container

Element	Description	Required	Multiplicity	Datatype
UniqueID	UniqueID uses the UniqueIDType from the MedBiquitous Healthcare Professional Profile.	Optional	0 to more	For more information, see ANSI/MEDBIQ 10.1-2008 Healthcare Professional Profile [Professional Profile].
Name	Name contains sub-elements that define a person's name in detail. Name uses the NameType from the MedBiquitous Healthcare Professional Profile.	Required	1 to 1	Container. For more information, see ANSI /MEDBIQ PP.10.1-2008 Name Specifications and Description Document [Name].
Address	Address contains sub-elements that define a postal address in detail. Address uses the AddressType from the MedBiquitous Healthcare Professional Profile.	Optional	0 to more	Container. For more information, see ANSI /MEDBIQ PP.10.1-2008 Address Specifications and Description Document [Address].
Email	EmailAddress defines a person's email address. Email uses the EmailType from the MedBiquitous Healthcare Professional Profile.	Optional	0 to more	Email address. For more information, see ANSI/MEDBIQ 10.1-2008 Healthcare Professional Profile [Professional Profile].
Telephone	Telephone contains sub-elements that define a person's telephone number. Telephone uses the ContactNumberType from the MedBiquitous Healthcare Professional Profile.	Optional	0 to more	Container. For more information, see ANSI/MEDBIQ 10.1-2008 Healthcare Professional Profile [Professional Profile].

Element	Description	Required	Multiplicity	Datatype
Any	Any elements defined by the organization implementing the schema provided those elements are defined in another namespace.	Optional	0 or more	Any datatype

Example:

```

<DisclosingIndividual>
  <Name>
    <n:GivenName>John</n:GivenName>
    <n:FamilyName>Smith</n:FamilyName>
  </Name>
  <Address><a:StreetAddressLine>1212 Ivory Lane</a:StreetAddressLine>
    <a:City>Boston</a:City>
    <a:StateOrProvince>MA</a:StateOrProvince>
    <a:PostalCode>22222</a:PostalCode>
    <a:Country>
      <a:CountryName>United States</a:CountryName>
    </a:Country>
  </Address>
  <Email>John.Smith@abc.org</Email>
  <Telephone>
    <m:TelephoneNumber>301-555-1212</m:TelephoneNumber>
  </Telephone>
</DisclosingIndividual>

```

8.5 FinancialDisclosureInformation

FinancialDisclosureInformation regards a set of financial interests or intellectual property.

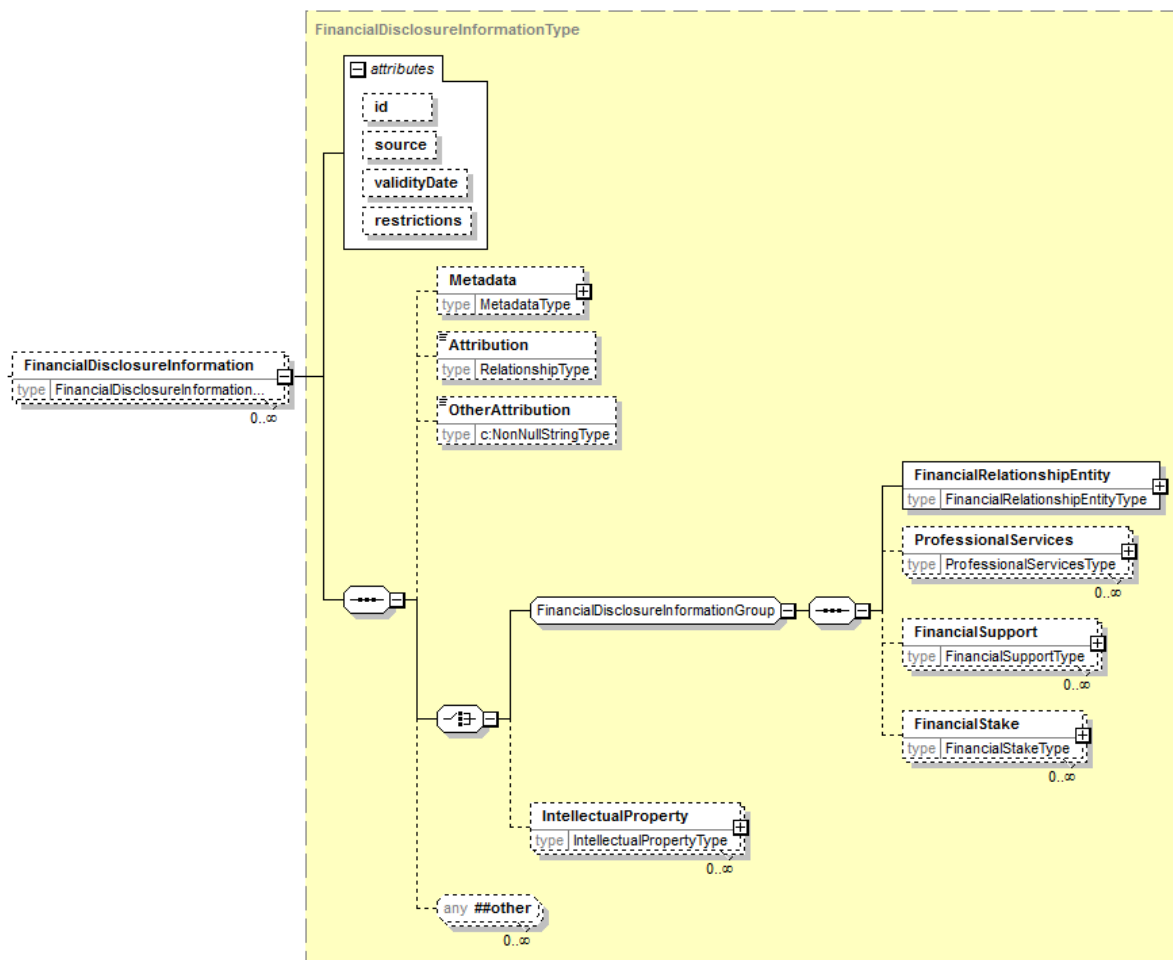

FinancialDisclosureInformation Information

Element	Description	Required	Multiplicity	Datatype
FinancialDisclosureInformation	Information regarding a set of financial interests with a particular company or in regards to intellectual property.	Optional	0 to more	Container
Metadata	Information about the creation, update, and disclosure profile for a set of information. For more information, see section Metadata.	Optional	0 to 1	Container
Attribution	The person to whom the financial interests are attributed. Allowed Values: Self SpouseOrPartner DependentChild Other	Optional	0 to 1	Restricted
OtherAttribution	The person to whom the financial interests are attributed. The "OtherAttribution" element should be used when the "Attribution" element is equal to "Other".	Optional	0 to 1	Non-null string
FinancialRelationshipEntity	The individual or organization with which the disclosing individual has a financial relationship. For more information, see sectionFinancialRelationshipEntity.	Required	1 to 1	Container
ProfessionalServices	Contains sub-elements that describe professional services provided to an entity. Professional services include employment, independent contractor, or fiduciary officer relationships. For more information, see section ProfessionalServices.	Optional	0 to more	Container
FinancialSupport	Contains sub-elements that describe financial support, including grants, travel, and gifts. For more information, see section FinancialSupport.	Optional	0 to more	Container

Element	Description	Required	Multiplicity	Datatype
FinancialStake	Contains sub-elements that define financial stake in an entity, including stocks, stock options, other securities, and ownership. For more information, see section FinancialStake.	Optional	0 to more	Container
IntellectualProperty	Information on intellectual property held, including patents, copyrights, trademarks, and other intellectual property. For more information, see section IntellectualProperty.	Optional	0 to more	Container
Any	Any elements defined by the organization implementing the schema provided those elements are defined in another namespace.	Optional	0 or more	Any datatype

Example:

```
<FinancialDisclosureInformation>
  <FinancialRelationshipEntity>
    <OrganizationEntity>
      <OrganizationName>ABC Corporation</OrganizationName>
      <Address>
        <a:StreetAddressLine>567 Security Boulevard</a:StreetAddressLine>
        <a:City>Baltimore</a:City>
        <a:StateOrProvince>MD</a:StateOrProvince>
        <a:PostalCode>22222</a:PostalCode>
        <a:Country>
          <a:CountryCode>US</a:CountryCode>
        </a:Country>
      </Address>
    </OrganizationEntity>
  </FinancialRelationshipEntity>
  <ProfessionalServices>
    ...
  </ProfessionalServices>
  <FinancialStake>
    ...
  </FinancialStake>
  <FinancialSupport>
    ...
  </FinancialSupport>
</FinancialDisclosureInformation>
```

or

```
<FinancialDisclosureInformation>
  <IntellectualProperty>
    ...
  </IntellectualProperty>
</FinancialDisclosureInformation>
```

8.6 FinancialRelationshipEntity

FinancialRelationshipEntity identifies the individual or organization the disclosing individual has a financial relationship.

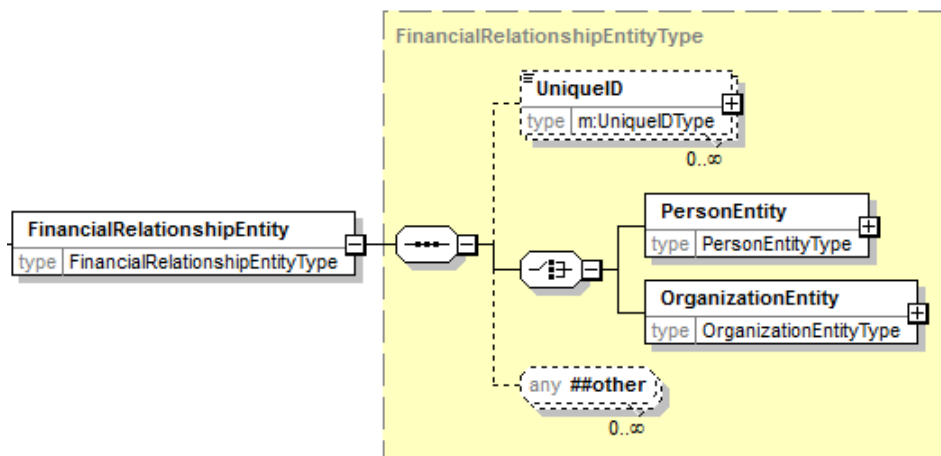

FinancialRelationshipEntity Information

Element	Description	Required	Multiplicity	Datatype
FinancialRelationshipEntity	The individual or organization with which the disclosing individual has a financial relationship.	Required	1 to 1	Container
UniqueID	A unique alphanumeric identifier for the individual. UniqueID has the following attribute: domain Defines the community, society, or organization that is the source of the unique id. Use of the domain attribute is required when using the UniqueID element. As a best practice, use the following format for the domain: idd:domainname:localidentifier	Optional	0 to more	Non-null String. For more information, see ANSI/MEDBIQ 10.1-2008 Healthcare Professional Profile [Professional Profile].

Element	Description	Required	Multiplicity	Datatype
	Where: domainname is an internet domain name owned by the organization issuing the unique ID and localidentifer is a local identifier for the type of unique ID. For more information, see ANSI /MEDBIQ PP.10.1-2008 Healthcare Professional Profile Specifications Document			
PersonEntity	The person with whom the disclosing individual has a financial relationship. For more information, see section PersonEntity.	Required	1 to 1	Container
OrganizationEntity	The organization with which the disclosing individual has a financial relationship. For more information, see section OrganizationEntity.	Required	1 to 1	Container
Any	Any elements defined by the organization implementing the schema provided those elements are defined in another namespace.	Optional	0 or more	Any datatype

Example:

```

<FinancialRelationshipEntity>
  <UniqueID domain="NASDAQ">AAPL</UniqueID>
  <OrganizationEntity>
    <OrganizationName>Apple Corporation</OrganizationName>
    <FormOfBusiness>IT Company</FormOfBusiness>
    <CompanyCategory>Public</CompanyCategory>
    <Address>
      <a:StreetAddressLine>1 Infinite Loop</a:StreetAddressLine>
      <a:City>Cupertino</a:City>
      <a:StateOrProvince>CA</a:StateOrProvince>
      <a:PostalCode>95014</a:PostalCode>
      <a:Country>
        <a:CountryCode>US</a:CountryCode>
      </a:Country>
    </Address>
  </OrganizationEntity>
</FinancialRelationshipEntity>

```

```

</Address>
<Telephone>
  <m:TelephoneNumber>408-996-1010</m:TelephoneNumber>
</Telephone>
<Email>info@apple.com</Email>
</OrganizationEntity>
</FinancialRelationshipEntity>
    
```

8.6.1 PersonEntity

PersonEntity identifies the person with a financial relationship to the disclosing individual.

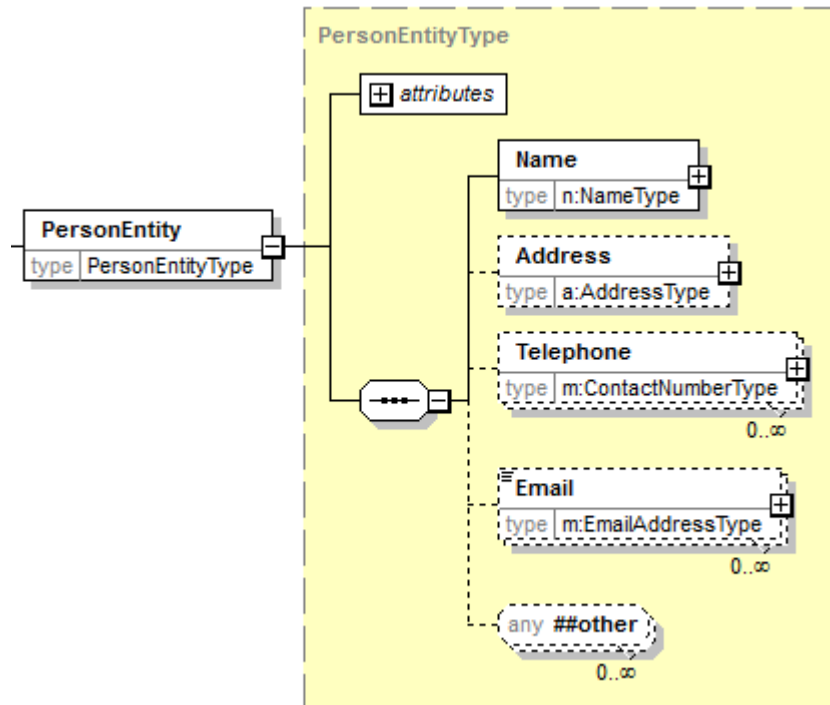

PersonEntity Element Information

Element	Description	Required	Multiplicity	Datatype
PersonEntity	<p>The person with whom the disclosing individual has a financial relationship.</p> <p>PersonEntity has the following attribute:</p> <p><i>id</i> – a identifier that uniquely identifies the PersonEntity in this XML document. Identifiers must start with a letter or underscore and can only contain letters, digits, underscores, hyphens, and periods.</p>	Required	1 to 1	Container
Name	Name contains sub-elements that define a person’s name in detail. Name uses the NameType from the MedBiquitous Healthcare Professional Profile.	Required	1 to 1	Container. For more information, see ANSI /MEDBIQ PP.10.1-2008 Name Specifications and Description Document [Name] .
Address	Address contains sub-elements that define a postal address in detail. Address uses the AddressType from the MedBiquitous Healthcare Professional Profile.	Optional	0 to 1	Container. For more information, see ANSI /MEDBIQ PP.10.1-2008 Address Specifications and Description Document [Address] .
Telephone	Telephone contains sub-elements that define a person's telephone number. Telephone uses the ContactNumberType from the MedBiquitous Healthcare Professional Profile.	Optional	0 to more	Container. For more information, see ANSI/MEDBIQ 10.1-2008 Healthcare Professional Profile [Professional Profile] .

Element	Description	Required	Multiplicity	Datatype
Email	EmailAddress defines a person's email address. Email uses the EmailType from the MedBiquitous Healthcare Professional Profile.	Optional	0 to more	Email address. For more information, see ANSI/MEDBIQ 10.1-2008 Healthcare Professional Profile [Professional Profile].
Any	Any elements defined by the organization implementing the schema provided those elements are defined in another namespace.	Optional	0 or more	Any datatype

Example:

```

<PersonEntity>
  <Name>
    <n:Title>Dr.</n:Title>
    <n:GivenName>Richie</n:GivenName>
    <n:FamilyName>Rich</n:FamilyName>
  </Name>
  <Address>
    <a:City>Manhattan</a:City>
    <a:StateOrProvince>NY</a:StateOrProvince>
    <a:Country>
      <a:CountryCode>US</a:CountryCode>
    </a:Country>
  </Address>
  <Telephone>
    <m:TelephoneNumber>212-555-1212</m:TelephoneNumber>
  </Telephone>
  <Email>rrich@philanthropy.org</Email>
</PersonEntity>

```

8.6.2 OrganizationEntity

OrganizationEntity identifies the organization with a financial relationship to the disclosing individual.

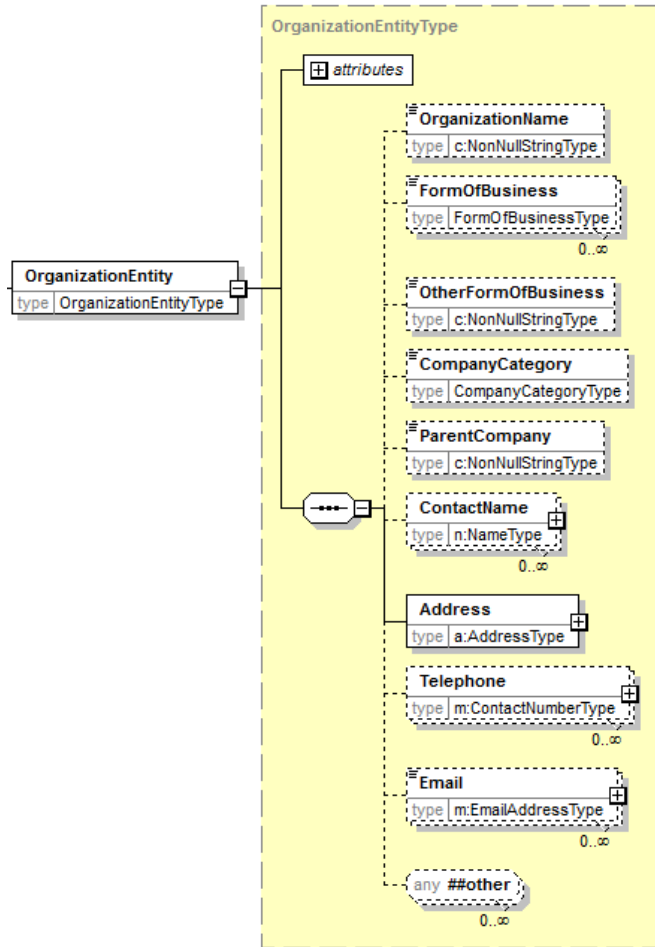

OrganizationEntity Information

Element	Description	Required	Multiplicity	Datatype
OrganizationEntity	The organization with which the disclosing individual has a financial relationship. OrganizationEntity has the following attribute: <i>id</i> – a identifier that uniquely identifies the OrganizationEntity in this XML document. Identifiers must start with a letter or underscore and can only contain letters, digits, underscores, hyphens, and periods.	Required	1 to 1	Container
OrganizationName	An organizational name.	Optional	0 to 1	Non-null string
FormOfBusiness	The type of business in which this entity engages. Allowed Values: Pharmaceutical Company Device Manufacturer Medical Supply Company Health Care Entity IT Company Investment Firm Other	Optional	0 or more	Restricted
OtherFormOfBusiness	The type of business in which this entity engages. This element should be used when the "FormOfBusiness" element is equal to "Other".	Optional	0 to 1	Non-null string
CompanyCategory	Identifying whether the company is a private or publicly held company. Allowed Values: Private Public	Optional	0 to 1	Restricted
ParentCompany	The parent company of the organization. The parent company should be indicated when the organization is a subsidiary to another organization.	Optional	0 to 1	Non-null string

Element	Description	Required	Multiplicity	Datatype
ContactName	A name of the main point of contact at the organization. ContactName uses the NameType from the MedBiquitous Healthcare Professional Profile.	Optional	0 to more	Container. For more information, see ANSI /MEDBIQ PP.10.1-2008 Address Specifications and Description Document [Address] .
Address	Address contains sub-elements that define a postal address in detail. Address uses the AddressType from the MedBiquitous Healthcare Professional Profile.	Required	1 to 1	Container. For more information, see ANSI /MEDBIQ PP.10.1-2008 Address Specifications and Description Document [Address] .
Telephone	Telephone contains sub-elements that define a person's telephone number. Telephone uses the ContactNumberType from the MedBiquitous Healthcare Professional Profile.	Optional	0 to more	Container. For more information, see ANSI/MEDBIQ 10.1-2008 Healthcare Professional Profile [Professional Profile] .

Element	Description	Required	Multiplicity	Datatype
Email	EmailAddress defines a person's email address. Email uses the EmailType from the MedBiquitous Healthcare Professional Profile.	Optional	0 to more	Email address. For more information, see ANSI/MEDBIQ 10.1-2008 Healthcare Professional Profile [Professional Profile] .
Any	Any elements defined by the organization implementing the schema provided those elements are defined in another namespace.	Optional	0 or more	Any datatype

Example:

```

<OrganizationEntity>
  <OrganizationName>Company A</OrganizationName>
  <FormOfBusiness>Device Manufacturer</FormOfBusiness>
  <ParentCompany>Corporation A</ParentCompany>
  <ContactName>
    <n:FormattedName>Joy Smith</n:FormattedName>
  </ContactName>
  <Address>
    <a:StreetAddressLine>1600 B Street, NW</a:StreetAddressLine>
    <a:City>Boston</a:City>
    <a:StateOrProvince>MA</a:StateOrProvince>
    <a:PostalCode>22222</a:PostalCode>
    <a:Country>
      <a:CountryCode>US</a:CountryCode>
    </a:Country>
  </Address>
  <Telephone>

```

```
<m:CountryCode>1</m:CountryCode>  
  <m:TelephoneNumber>888-888-8881</m:TelephoneNumber>  
</Telephone>  
  <Email>info@companya.com</Email>  
</OrganizationEntity>
```

8.7 ProfessionalServices

ProfessionalServices contains sub-elements that describe professional services provided.

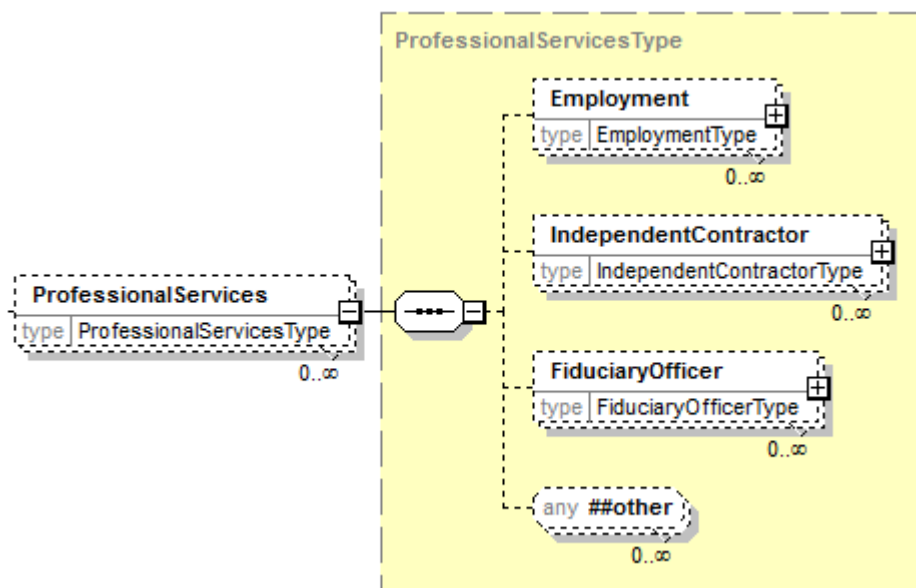

ProfessionalServices Information

Element	Description	Required	Multiplicity	Datatype
ProfessionalServices	Contains sub-elements that describe professional services provided to an entity. Professional services include employment, independent contractor, or fiduciary officer relationships.	Optional	0 to more	ProfessionalServices
Employment	Contains sub-elements that describe an individual's employment with an entity. Attributes: <i>financialInterestExists</i> - Indicates whether or not a financial interest exists. This attribute is optional and	Optional	0 to more	Employment

Element	Description	Required	Multiplicity	Datatype
	should be used when further information isn't required by the organization.			
IndependentContractor	Contains sub-elements that describe an independent contractor relationship with an entity. Attributes: <i>financialInterestExists</i> - The 'financialInterestExists' attribute can be used to show the existence of a financial interest. This attribute is optional and should be used when further information isn't required by organization.	Optional	0 to more	IndependentContractor
FiduciaryOfficer	Contains sub-elements that describe in individual's fiduciary officer relationship with an entity. Attributes: <i>financialInterestExists</i> - The 'financialInterestExists' attribute can be used to show the existence of a financial interest. This attribute is optional and should be used when further information isn't required by organization.	Optional	0 to more	FiduciaryOfficer
Any	Any elements defined by the organization implementing the schema provided those elements are defined in another namespace.	Optional	0 or more	Any datatype

Example:

```
<ProfessionalServices>
  <Employment>
    ...
  </Employment>
  <IndependentContractor>
    ...
  </IndependentContractor>
```

```
<FiduciaryOfficer>  
  ...  
</FiduciaryOfficer>  
</ProfessionalServices>
```

8.7.1 Employment

Employment identifies an individual’s employment with an entity.

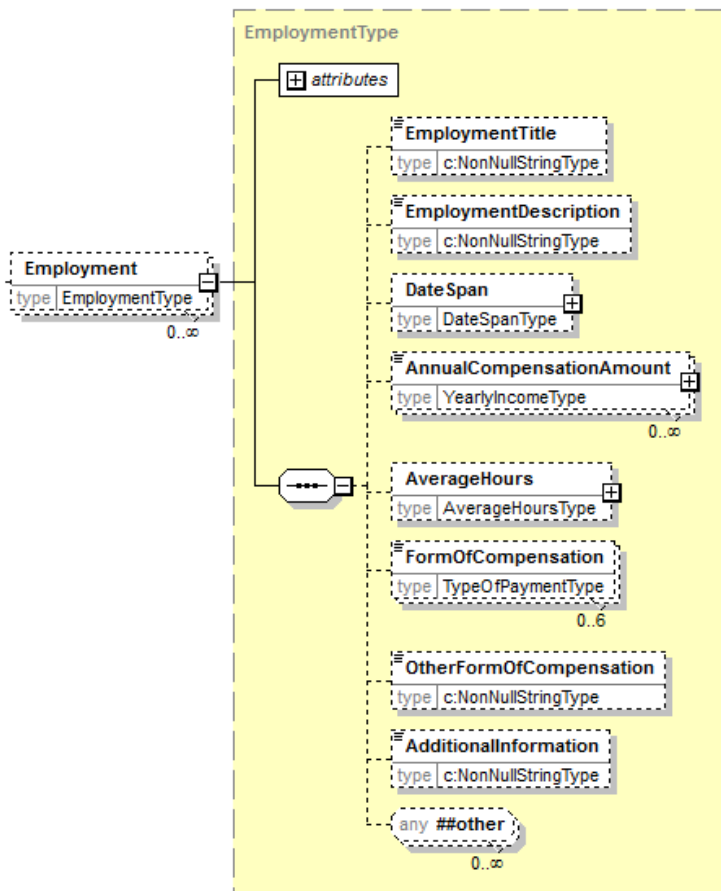

Employment Information

Element	Description	Required	Multiplicity	Datatype
Employment	Contains sub-elements that describe an individual's employment with an entity. Attributes: <i>financialInterestExists</i> - Indicates whether or not a financial interest exists. This attribute is optional and should be used when further information isn't required by the organization.	Optional	0 to more	Container
EmploymentTitle	Title of an individual for the purposes of their employment.	Optional	0 to 1	Non-null string
EmploymentDescription	Descriptive information concerning an individual's employment.	Optional	0 to 1	Non-null string
DateSpan	A date span with a "begin" and optional "end" date.	Optional	0 to 1	
AnnualCompensationAmount	The annual compensation amount. Attributes: <i>year</i> - The year in which the compensation was earned. <i>type</i> - Valid values are Actual and estimated. (Allowed values: Actual, Estimated) <i>valuationDate</i> - The date the value was assessed. <i>currencyCode</i> - The currency code of the amount indicated. Recommended values are ISO 4217 3-letter alphabetic codes. For example, USD for US dollar, CAD for the Canadian dollar, and EUR for the Euro. Valid values are limited to 3-character strings.	Optional	0 to more	Non-null string
AverageHours	The average hours an individual works in a week, month or year. For more information, see section AverageHours.	Optional	0 to 1	Container

Element	Description	Required	Multiplicity	Datatype
FormOfCompensation	The form of compensation that an individual receives. Allowed Values: Cash Equity Equity Options Ownership Unpaid Other	Optional	0 to 6	Restricted
OtherFormOfCompensation	The form of compensation that an individual receives. The "OtherFormOfCompensation" element should be used when the value of "FormOfCompensation" element is equal to "Other".	Optional	0 to 1	Non-null string
AdditionalInformation	Any additional information about this interest	Optional	0 or 1	Non-null string
Any	Any elements defined by the organization implementing the schema provided those elements are defined in another namespace.	Optional	0 or more	Any datatype

Example:

```

<Employment>
  <DateSpan>
    <BeginDate>1999-01-01</BeginDate>
  </DateSpan>
  <AnnualCompensationAmount>175000</AnnualCompensationAmount>
  <AverageHours>
    <NumberOfHours>40</NumberOfHours>
    <Duration>Week</Duration>
  </AverageHours>
  <FormOfCompensation>Cash</FormOfCompensation>
</Employment>

```

IndependentContractor

IndependentContractor describes the relationship between an independent contractor and an entity.

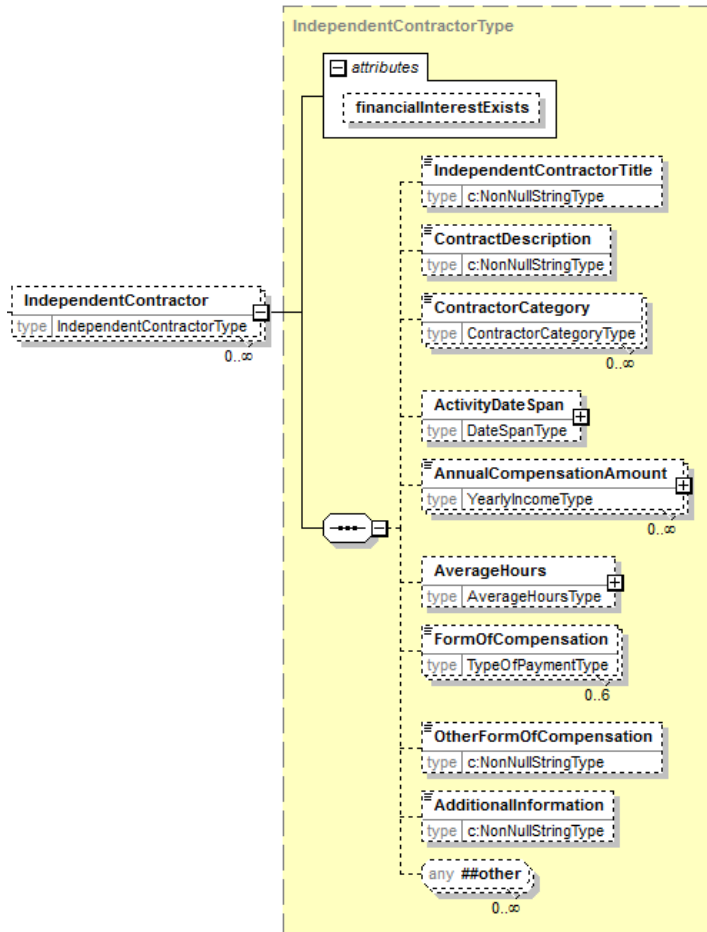

IndependentContractor Information

Element	Description	Required	Multiplicity	Datatypes
IndependentContractor	Contains sub-elements that describe an independent contractor relationship with an entity. <i>Attributes:</i> <i>financialInterestExists</i> - The 'financialInterestExists' attribute can be used to show the existence of a financial interest. This attribute is optional and should be used when further information isn't required by organization.	Optional	0 to more	Container
IndependentContractorTitle	Title of an individual for the purposes of their independent contractor position.	Optional	0 to 1	Non-null string
ContractDescription	Descriptive information concerning an individual's contracting responsibilities.	Optional	0 to 1	Non-null string
ContractorCategory	The contractor category type. This element contains an enumerated list of valid categories. <i>Allowed Values:</i> Consultant Expert Witness Data And Safety Monitoring Professional Investigator End Point Review Committee	Optional	0 to more	Restricted.
ActivityDateSpan	The date of the activity span with a "begin" and optional "end" date. For more information, see section ActivityDateSpan.	Optional	0 to 1	Container
AnnualCompensationAmount	The annual compensation amount. <i>Attributes:</i> <i>year</i> - The year in which the compensation was earned. <i>type</i> - Valid values are Actual and Estimated. (Allowed values: Actual, Estimated) <i>valuationDate</i> - The date the value was assessed. <i>currencyCode</i> - The currency code of the amount indicated.	Optional	0 to more	Non-null string

Element	Description	Required	Multiplicity	Datatypes
	Recommended values are ISO 4217 3-letter alphabetic codes. For example, USD for US dollar, CAD for the Canadian dollar, and EUR for the Euro. Valid values are limited to 3-character strings.			
AverageHours	The average hours an individual works in a week, month or year. For more information, see section AverageHours.	Optional	0 to 1	Container
FormOfCompensation	The form of compensation that an individual receives Allowed Values: Cash Equity EquityOptions Ownership Unpaid Other	Optional	0 to 6	Restricted
OtherFormOfCompensation	The form of compensation that an individual receives. "OtherFormOfCompensation" element should be used when the value of "FormOfCompensation" element is equal to "Other".	Optional	0 to 1	Non-null string
AdditionalInformation	Any additional information about this interest	Optional	0 or 1	Non-null string
Any	Any elements defined by the organization implementing the schema provided those elements are defined in another namespace.	Optional	0 or more	Any datatype

Example:

```
<IndependentContractor>
  <ContractorCategory>Consultant</ContractorCategory>
  <ActivityDateSpan>
    <BeginDate>2013-03-15</BeginDate>
    <EndDate>2014-12-30</EndDate>
  </ActivityDateSpan>
  <AnnualCompensationAmount year="2013" type="Actual"
currencyCode="US">5000</AnnualCompensationAmount>
  <AnnualCompensationAmount year="2014" type="Estimated"
currencyCode="US">10000</AnnualCompensationAmount>
  <FormOfCompensation>Equity</FormOfCompensation>
</IndependentContractor>
```

8.7.3 FiduciaryOfficer

FiduciaryOfficer describes the relationship between an individual’s fiduciary officer and an entity.

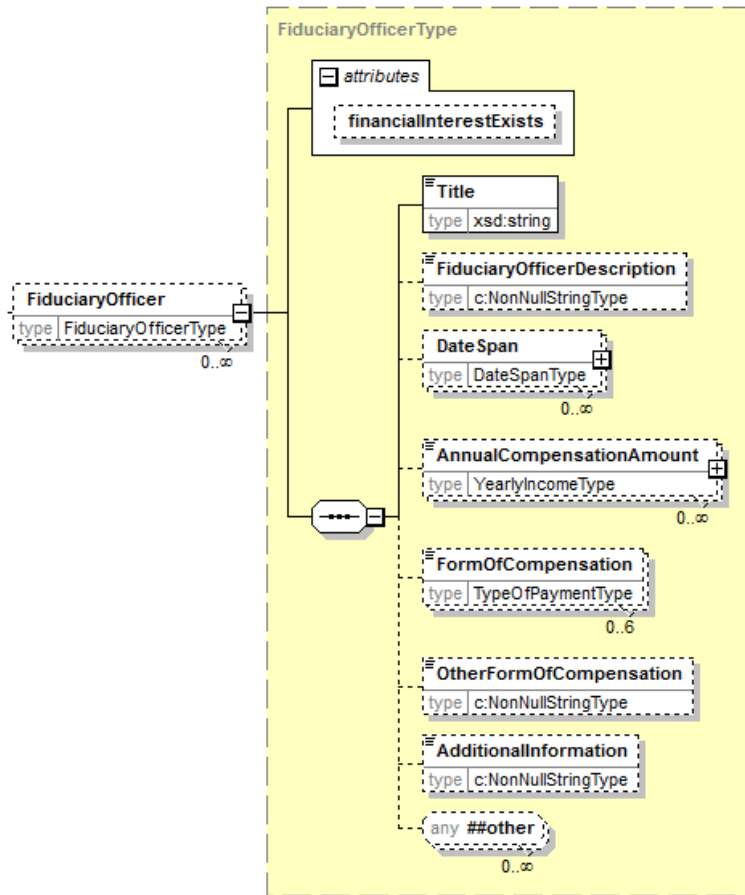

FiduciaryOfficer Information

Element	Description	Required	Multiplicity	Datatype
FiduciaryOfficer	Contains sub-elements that describe in individual's fiduciary officer relationship with an entity. Attributes: <i>financialInterestExists</i> - The 'financialInterestExists' attribute can be used to show the existence of a financial interest. This attribute is optional and should be used when further information isn't required by organization.	Optional	0 to more	Container
Title	The official title of the fiduciary position.	Optional	1 to 1	Non-null string
FiduciaryOfficerDescription	Descriptive information concerning the Fiduciary Officer position.	Optional	0 to 1	Non-null string
DateSpan	A date span with a "begin" and optional "end" date.	Optional	0 to more	
AnnualCompensationAmount	The annual compensation amount. Attributes: <i>year</i> - The year in which the compensation was earned <i>type</i> - Valid values are Actual and Estimated. (Allowed values: Actual, Estimated) <i>valuationDate</i> - The date the value was assessed. <i>currencyCode</i> - The currency code of the amount indicated. Recommended values are ISO 4217 3-letter alphabetic codes. For example, USD for US dollar, CAD for the Canadian dollar, and EUR for the Euro. Valid values are limited to 3-character strings.	Optional	0 to more	Non-null string
FormOfCompensation	The form of compensation that an individual receives. Allowed Values: Cash Equity Equity Options	Optional	0 to 6	Restricted

	Ownership Unpaid Other			
OtherFormOfCompensation	The form of compensation that an individual receives. The "OtherFormOfCompensation" element should be used when the value of "FormOfCompensation" element is equal to "Other".	Optional	0 to 1	Non-null string
AdditionalInformation	Any additional information about this interest	Optional	0 or 1	Non-null string
Any	Any elements defined by the organization implementing the schema provided those elements are defined in another namespace.	Optional	0 or more	Any datatype

Example:

```

<FiduciaryOfficer>
  <Title>Board Member</Title>
  <DateSpan>
    <BeginDate>2010-01-01</BeginDate>
  </DateSpan>
  <AnnualCompensationAmount>2500</AnnualCompensationAmount>
  <FormOfCompensation>Other</FormOfCompensation>
</FiduciaryOfficer>

```

8.8 FinancialSupport

FinancialSupport describes financial support that includes grants, travel, and gifts.

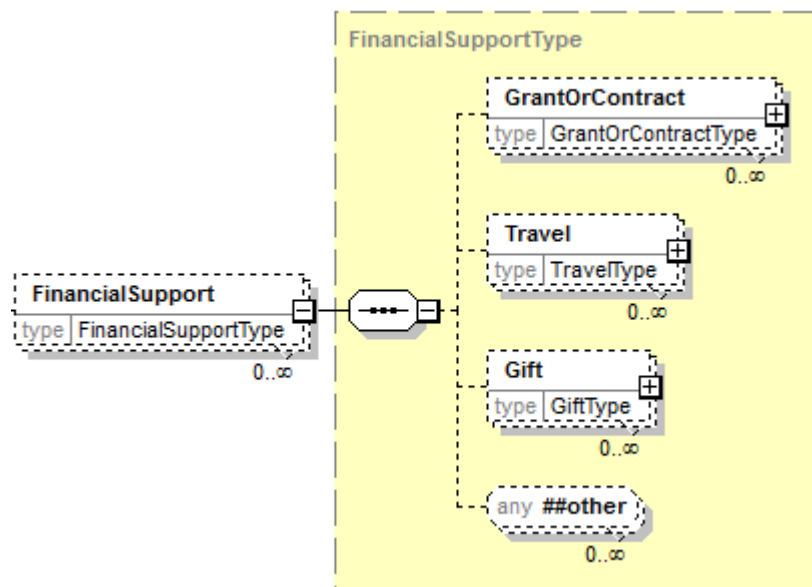

FinancialSupport Information

Element	Description	Required	Multiplicity	Datatype
FinancialSupport	Contains sub-elements that describe financial support, including grants, travel, and gifts.	Optional	0 to more	Container
GrantOrContract	Contains sub-elements that describe a grant or contract from an entity. Attributes: <i>financialInterestExists</i> - The 'financialInterestExists' attribute can be used to show the existence of a financial interest. This attribute is optional and should be used when further information isn't required by organization.	Optional	0 to more	Container

Element	Description	Required	Multiplicity	Datatype
	For more information, see section GrantOrContract.			
Travel	<p>Contains sub-elements that describe travel paid for by an entity.</p> <p>Attributes:</p> <p><i>financialInterestExists</i> - The 'financialInterestExists' attribute can be used to show the existence of a financial interest. This attribute is optional and should be used when further information isn't required by organization.</p> <p>For more information, see section Travel.</p>	Optional	0 to more	Container
Gift	<p>Contains sub-elements that describe a gift from an entity.</p> <p>Attributes:</p> <p><i>financialInterestExists</i> - The 'financialInterestExists' attribute can be used to show the existence of a financial interest. This attribute is optional and should be used when further information isn't required by organization.</p> <p>For more information, see section Gift.</p>	Optional	0 to more	Container
Any	Any elements defined by the organization implementing the schema provided those elements are defined in another namespace.	Optional	0 or more	Any datatype

Example:

```

<FinancialSupport>
  <GrantOrContract>
    ...
  </GrantOrContract>
  <Travel>
    ...
  </Travel>
  <Gift>
    ...

```

```
</Gift>  
</FinancialSupport>
```

8.8.1 GrantOrContract

GrantOrContract describe a grant or contract from an entity.

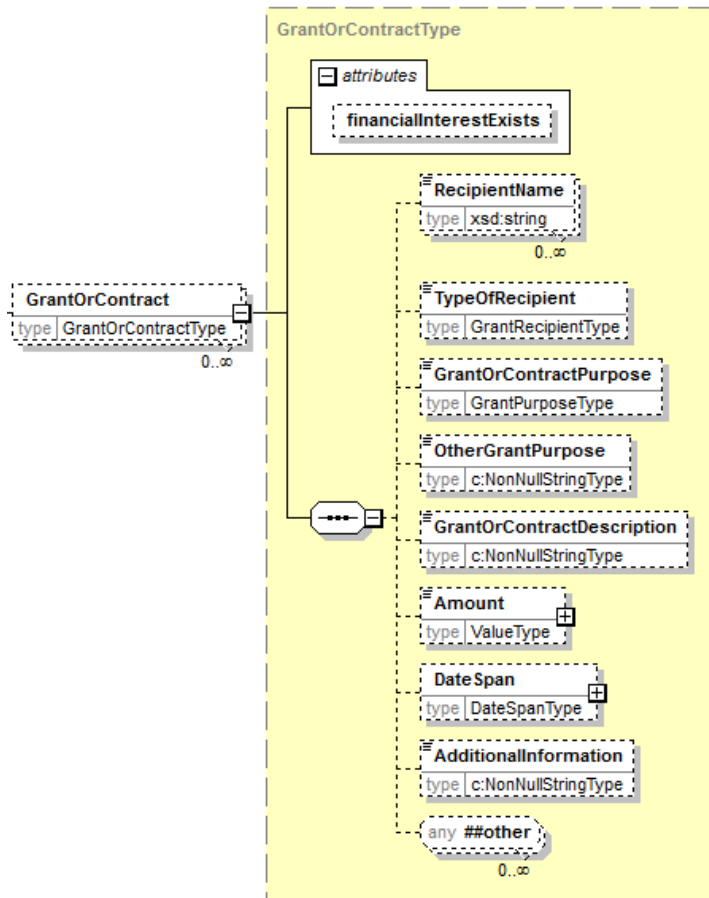

GrantOrContract Information

Element	Description	Required	Multiplicity	Datatype
GrantOrContract	Contains sub-elements that describe a grant or contract from an entity. Attributes: <i>financialInterestExists</i> - The 'financialInterestExists' attribute can be used to show the existence of a financial interest. This attribute is optional and should be used when further information isn't required by organization.	Optional	0 to more	Container
RecipientName	The name of the entity receiving a grant.	Optional	0 to more	Non-null string
TypeOfRecipient	Indicates whether the grant was received by the individual or institution. Allowed Values: Individual Institution	Optional	0 to 1	Restricted
GrantOrContractPurpose	The purpose of the grant. Allowed Values: Research Other	Optional	0 to 1	Restricted
OtherGrantPurpose	The purpose of the grant or contract. This element should be used when the value of the GrantOrContractPurpose is Other.	Optional	0 to 1	Non-null string
GrantOrContractDescription	A description of the grant or contract, potentially including the title.	Optional	0 to 1	Non-null string
Amount	The total amount of the grant. Attributes: <i>currencyCode</i> - The currency code of the amount indicated. Recommended values are ISO 4217 3-letter alphabetic codes. For example, USD for US dollar, CAD for the Canadian dollar, and EUR	Optional	0 to 1	Integer

Element	Description	Required	Multiplicity	Datatype
	for the Euro. Valid values are limited to 3-character strings. <i>valuationDate</i> - The date the value was assessed.			
DateSpan	A date span with a “begin” and optional “end” date. For more information, see section DateSpan.	Optional	0 to 1	Container
AdditionalInformation	Any additional information about this interest	Optional	0 or 1	Non-null string
Any	Any elements defined by the organization implementing the schema provided those elements are defined in another namespace.	Optional	0 or more	Any datatype

Example:

```

<FinancialSupport>
  <GrantOrContract>
    <RecipientName>George Washington</RecipientName>
    <TypeOfRecipient>Individual</TypeOfRecipient>
    <GrantOrContractPurpose>Research</GrantOrContractPurpose>
    <Amount>2500</Amount>
    <DateSpan>
      <BeginDate>2011-01-01</BeginDate>
      <EndDate>2011-12-30</EndDate>
    </DateSpan>
  </GrantOrContract>
  <GrantOrContract>
    <RecipientName>University A</RecipientName>
    <TypeOfRecipient>Institution</TypeOfRecipient>
    <GrantOrContractPurpose>Research</GrantOrContractPurpose>
    <Amount>5000</Amount>
    <DateSpan>
      <BeginDate>2013-01-01</BeginDate>
      <EndDate>2014-12-30</EndDate>
    </DateSpan>
  </GrantOrContract>
</FinancialSupport>

```

```
</DateSpan>  
</GrantOrContract>  
</FinancialSupport>
```

8.8.2 Travel

Travel is the amount travel paid for by an entity.

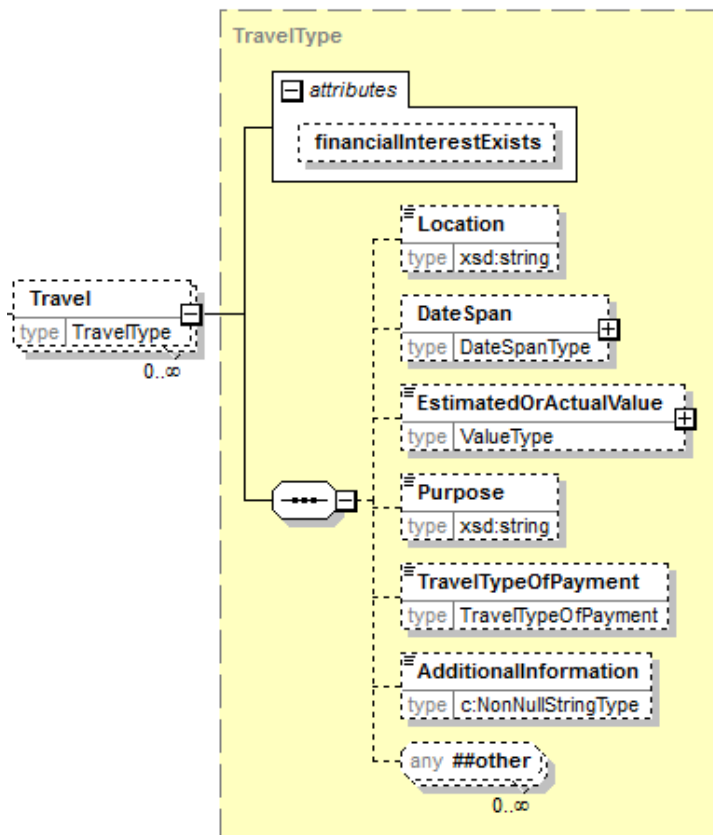

Travel Information

Element	Description	Required	Multiplicity	Datatype
Travel	Contains sub-elements that describe travel paid for by an entity. Attributes: <i>financialInterestExists</i> - The 'financialInterestExists' attribute	Optional	0 to more	Container

Element	Description	Required	Multiplicity	Datatype
	can be used to show the existence of a financial interest. This attribute is optional and should be used when further information isn't required by organization.			
Location	The location(s) to which the travel occurred.	Optional	0 to 1	Non-null string
DateSpan	A date span with a "begin" and optional "end" date. For more information, see section DateSpan.	Optional	0 to 1	Container
EstimatedOrActualValue	The estimated or actual value of the travel. Attributes: <i>currencyCode</i> - The currency code of the amount indicated. Recommended values are ISO 4217 3-letter alphabetic codes. For example, USD for US dollar, CAD for the Canadian dollar, and EUR for the Euro. Valid values are limited to 3-character strings. <i>valuationDate</i> - The date the value was assessed.	Optional	0 to 1	Integer
Purpose	The purpose of the travel.	Optional	0 to 1	Non-null string
TravelTypeOfPayment	An indication as to whether the travel was sponsored, where the entity paid for the travel up front, or reimbursed, where the individual paid for the travel and was then reimbursed by the entity. Allowed Values: Sponsored Reimbursed	Optional	0 to 1	Restricted
AdditionalInformation	Any additional information about this interest	Optional	0 or 1	Non-null string
Any	Any elements defined by the organization implementing the schema provided those elements are defined in another namespace.	Optional	0 or more	Any datatype

Example:

```
<Travel>
  <Location>San Diego, Ca.</Location>
  <DateSpan>
    <BeginDate>2014-03-12</BeginDate>
    <EndDate>2014-03-17</EndDate>
  </DateSpan>
  <EstimatedValue currencyCode="US" valuationDate="2014-03-17">6000</EstimatedValue>
  <Purpose>Presentation at conference</Purpose>
  <TravelTypeOfPayment>Reimbursed</TravelTypeOfPayment>
</Travel>
```

8.8.3 Gift

Gift is the gift from an entity.

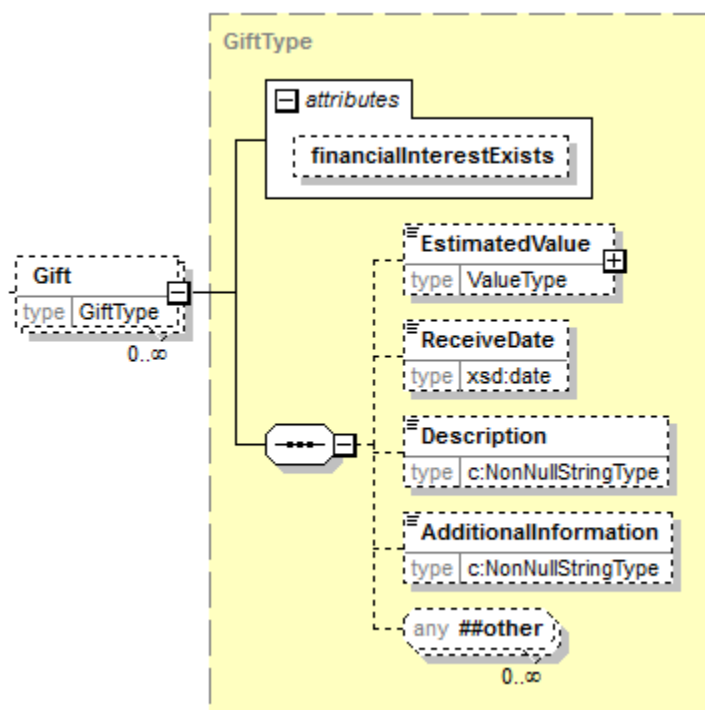

Gift Information

Element	Description	Required	Multiplicity	Datatype
Gift	Contains sub-elements that describe a gift from an entity. Attributes: <i>financialInterestExists</i> - The 'financialInterestExists' attribute can be used to show the existence of a financial interest. This attribute is optional and should be used when further information isn't required by organization.	Optional	0 to more	Container
EstimatedValue	The estimated value of the gift. Attributes: <i>currencyCode</i> - The currency code of the amount indicated. Recommended values are ISO 4217 3-letter alphabetic codes. For example, USD for US dollar,	Optional	0 to 1	Integer

Element	Description	Required	Multiplicity	Datatype
	CAD for the Canadian dollar, and EUR for the Euro. Valid values are limited to 3-character strings. <i>valuationDate</i> - The date the value was assessed.			
ReceiveDate	The date the gift is received.	Optional	0 to 1	Date
Description	A description of the gift.	Optional	0 to 1	Non-null string
AdditionalInformation	Any additional information about this interest	Optional	0 or 1	Non-null string
Any	Any elements defined by the organization implementing the schema provided those elements are defined in another namespace.	Optional	0 or more	Any datatype

Example:

```
<Gift>
  <EstimatedValue currencyCode="US" valuationDate="2014-06-06">1000</EstimatedValue>
  <ReceiveDate>2014-06-06</ReceiveDate>
  <Description>Hip Replacement Device</Description>
</Gift>
```

8.9 FinancialStake

FinancialStake defines financial stake in an entity.

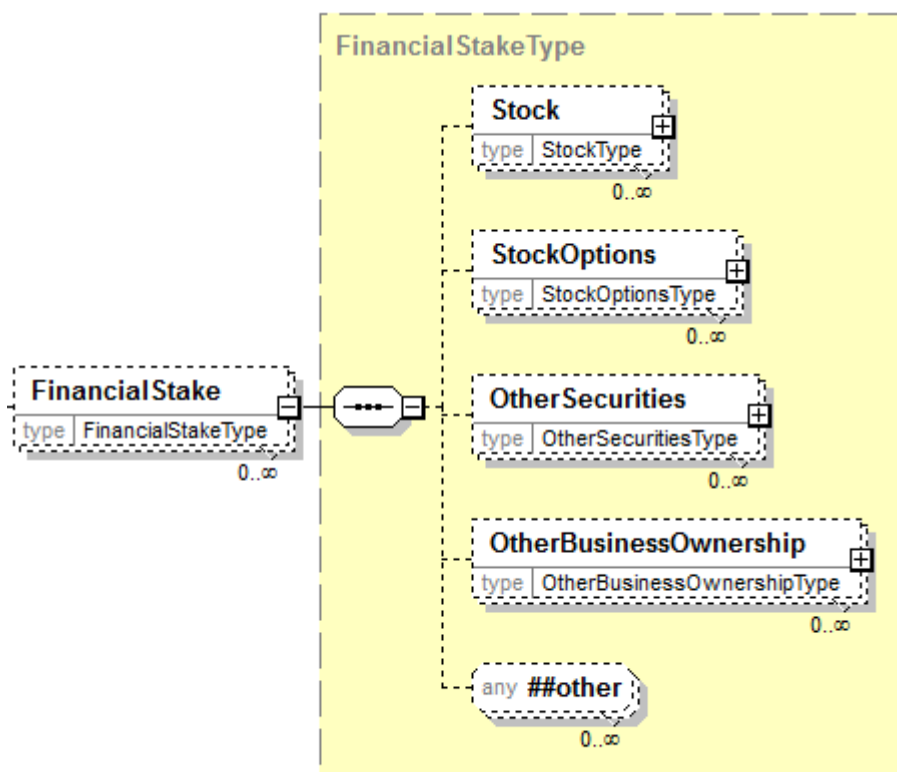

Generated by XMLSpy

www.altova.com

FinancialStake Information

Element	Description	Required	Multiplicity	Datatype
FinancialStake	Contains sub-elements that define financial stake in an entity, including stocks, stock options, other securities, and ownership.	Optional	0 to more	Container
Stock	Contains sub-elements that define stock held in an entity. Attributes:	Optional	0 to more	Container

Element	Description	Required	Multiplicity	Datatype
StockOptions	<p><i>financialInterestExists</i> - The 'financialInterestExists' attribute can be used to show the existence of a financial interest. This attribute is optional and should be used when further information isn't required by organization.</p> <p>For more information, see section Stock.</p> <p>Contains sub-elements that define stock options for an entity in detail.</p> <p>Attributes:</p> <p><i>financialInterestExists</i> - The 'financialInterestExists' attribute can be used to show the existence of a financial interest. This attribute is optional and should be used when further information isn't required by organization.</p> <p>For more information, see section Stock Options.</p>	Optional	0 to more	Container
OtherSecurities	<p>Details on securities that are not stock or stock options, i.e., bonds, convertible securities, etc.</p> <p>Attributes:</p> <p><i>financialInterestExists</i> - The 'financialInterestExists' attribute can be used to show the existence of a financial interest. This attribute is optional and should be used when further information isn't required by organization.</p> <p>For more information, see section OtherSecurities.</p>	Optional	0 to more	Container
OtherBusinessOwnership	<p>Contains sub-elements that describe whole or partial ownership of an entity.</p> <p>Attributes:</p> <p><i>financialInterestExists</i> - The 'financialInterestExists' attribute can be used to show the existence of a financial interest. This attribute is optional and should be used when further information isn't required by organization.</p>	Optional	0 to more	Container

Element	Description	Required	Multiplicity	Datatype
Any	For more information, see section OtherBusinessOwnership. Any elements defined by the organization implementing the schema provided those elements are defined in another namespace.	Optional	0 or more	Any datatype

Example:

```

<FinancialStake>
  <Stock>
    ...
  </Stock>
  <StockOptions>
    ...
  </StockOptions>
  <OtherSecurities>
    ...
  </OtherSecurities>
  <OtherBusinessOwnership>
    ...
  </OtherBusinessOwnership>
</FinancialStake>

```

8.9.1 Stock

Stock defines stock held in an entity.

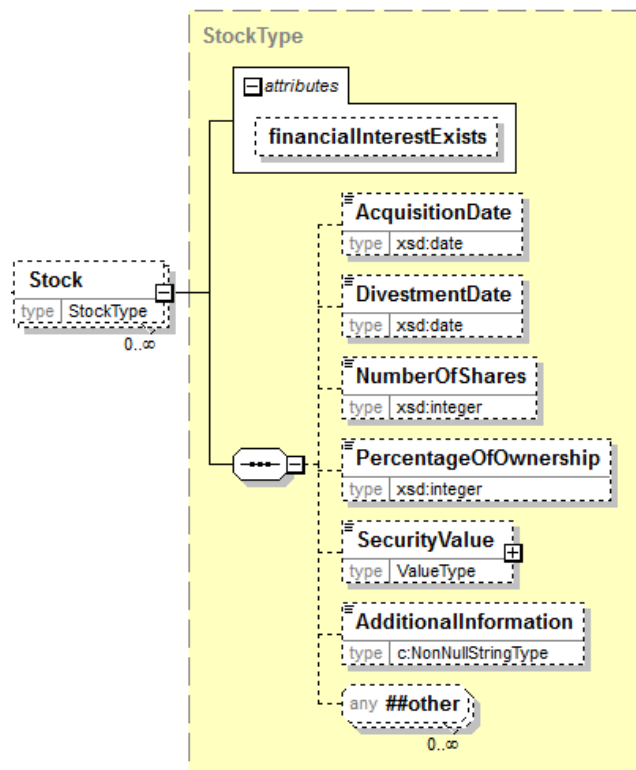

Stock Information

Element	Description	Required	Multiplicity	Datatype
Stock	Contains sub-elements that define stock held in an entity. Attributes: <i>financialInterestExists</i> - The 'financialInterestExists' attribute can be used to show the existence of a financial interest. This attribute is optional and should	Optional	0 to more	Container

Element	Description	Required	Multiplicity	Datatype
	be used when further information isn't required by organization.			
AcquisitionDate	The date of acquisition of the security.	Optional	0 to 1	Date
DivestmentDate	The date of divestment of the security.	Optional	0 to 1	Date
NumberOfShares	The total number of shares owned.	Optional	0 to 1	Number
PercentageOfOwnership	The percentage of ownership. Mainly used for privately held companies.	Optional	0 to 1	Number
SecurityValue	The value of the security at the time the disclosure is completed. Attributes: <i>currencyCode</i> - The currency code of the amount indicated. Recommended values are ISO 4217 3-letter alphabetic codes. For example, USD for US dollar, CAD for the Canadian dollar, and EUR for the Euro. Valid values are limited to 3-character strings. <i>valuationDate</i> - The date the value was assessed.	Optional	0 to 1	Integer
AdditionalInformation	Any additional information about this interest	Optional	0 or 1	Non-null string
Any	Any elements defined by the organization implementing the schema provided those elements are defined in another namespace.	Optional	0 or more	Any datatype

Example:

```

<FinancialStake>
  <Stock>
    <AcquisitionDate>2012-03-15</AcquisitionDate>
    <DivestmentDate>2014-09-12</DivestmentDate>
  </Stock>

```



```

<Stock>
  <AcquisitionDate>2013-02-15</AcquisitionDate>
  <NumberOfShares>200</NumberOfShares>
  <SecurityValue valuationDate="2014-01-01">260000</SecurityValue>
</Stock>
</FinancialStake>
    
```

8.9.2 StockOptions

StockOptions defines stock options for an entity.

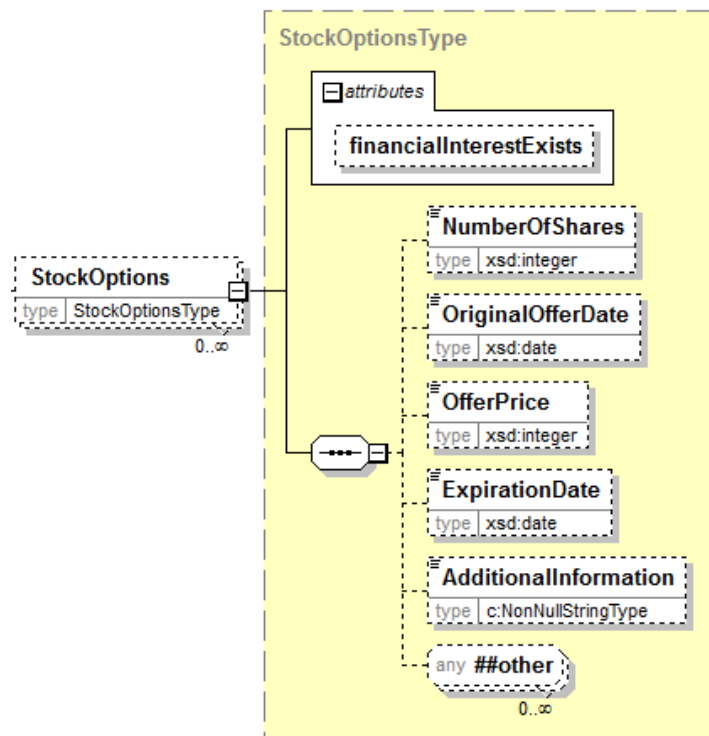

StockOptions Information

Element	Description	Required	Multiplicity	Datatype
StockOptions	Contains sub-elements that define stock options for an entity in detail. Attributes: <i>financialInterestExists</i> - The 'financialInterestExists' attribute can be used to show the existence of a financial interest. This attribute is optional and should be used when further information isn't required by organization.	Optional	0 to more	Container
NumberOfShares	The total number of shares owned.	Optional	0 to 1	Number
OriginalOfferDate	The date the stock options were offered.	Optional	0 to 1	Date
OfferPrice	The offer price of the stock options.	Optional	0 to 1	Number
ExpirationDate	The date the stock options will expire.	Optional	0 to 1	Date
AdditionalInformation	Any additional information about this interest	Optional	0 or 1	Non-null string
Any	Any elements defined by the organization implementing the schema provided those elements are defined in another namespace.	Optional	0 or more	Any datatype

Example:

```

<StockOptions>
  <NumberOfShares>1000</NumberOfShares>
  <OriginalOfferDate>2015-06-30</OriginalOfferDate>
  <OfferPrice>10</OfferPrice>
  <ExpirationDate>2017-01-01</ExpirationDate>
</StockOptions>

```

8.9.3 OtherSecurities

OtherSecurities identifies securities that are not stock or stock options.

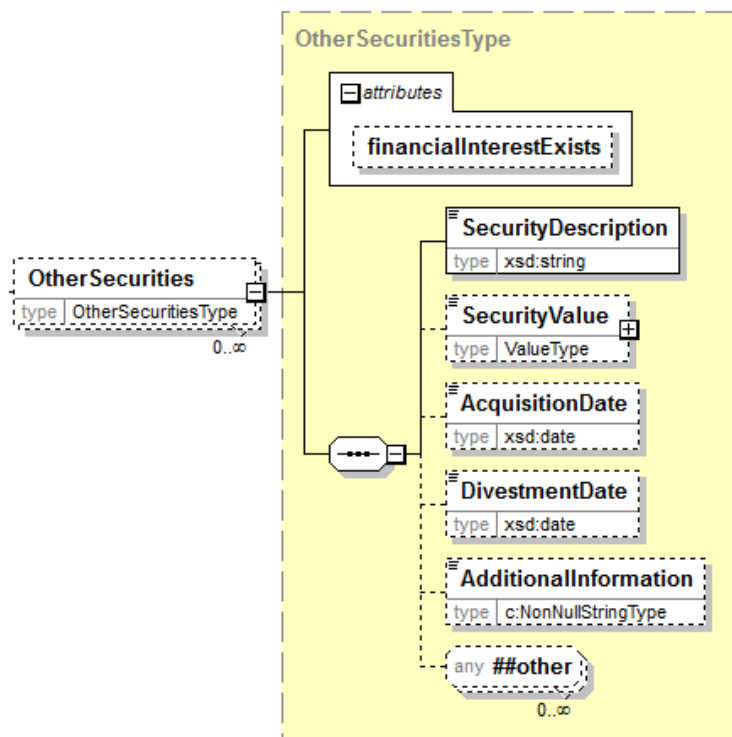

OtherSecurities Information

Element	Description	Required	Multiplicity	Datatype
OtherSecurities	Details on securities that are not stock or stock options, i.e., bonds, convertible securities, etc. Attributes: <i>financialInterestExists</i> - The 'financialInterestExists' attribute can be used to show the existence of a financial interest. This attribute is optional and should be used when further information isn't required by organization.	Optional	0 to more	Container
SecurityDescription	A Non-null string description of the held security.	Required	1 to 1	Non-null string
SecurityValue	The estimated value of the security. Attributes: <i>currencyCode</i> - The currency code of the amount indicated. Recommended values are ISO 4217 3-letter alphabetic codes. For example, USD for US dollar, CAD for the Canadian dollar, and EUR for the Euro. Valid values are limited to 3-character strings. <i>valuationDate</i> - The date the value was assessed.	Optional	0 to 1	Integer
AcquisitionDate	The date of acquisition of the security.	Optional	0 to 1	Date
DivestmentDate	The date of divestment of the security.	Optional	0 to 1	Date
AdditionalInformation	Any additional information about this interest	Optional	0 or 1	Non-null string
Any	Any elements defined by the organization implementing the schema provided those elements are defined in another namespace.	Optional	0 or more	Any datatype

Example:

```
<OtherSecurities>
  <SecurityDescription>Municipal Bonds</SecurityDescription>
```

```
<SecurityValue valuationDate="2014-03-03">5000</SecurityValue>  
<AcquisitionDate>2012-01-12</AcquisitionDate>  
<DivestmentDate>2014-12-03</DivestmentDate>  
</OtherSecurities>
```

8.9.4 OtherBusinessOwnership

OtherBusinessOwnership describes whole or partial ownership of an entity.

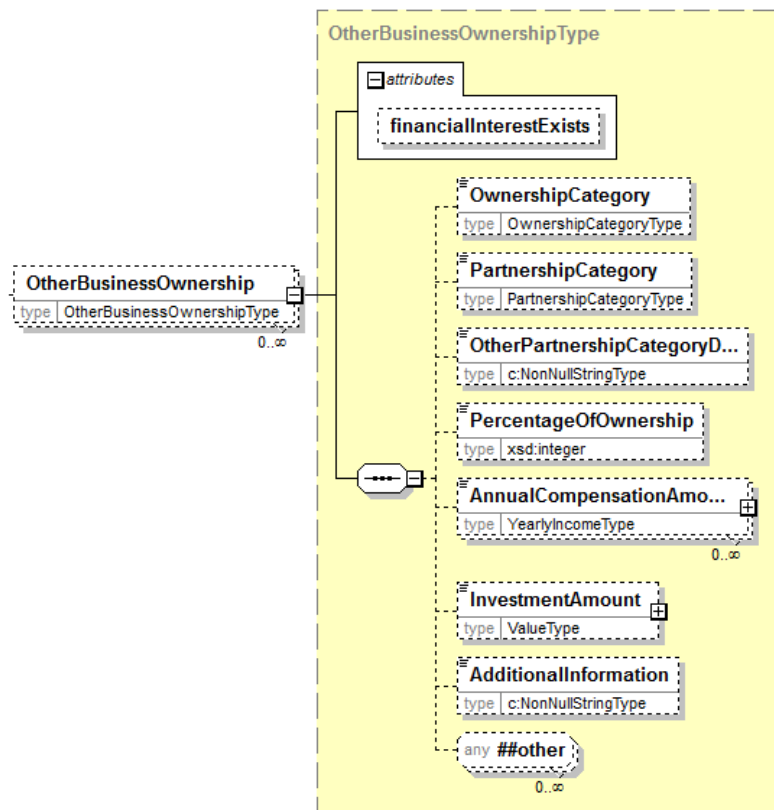

OtherBusinessOwnership Information

Element	Description	Required	Multiplicity	Datatype
OtherBusinessOwnership	Contains sub-elements that describe whole or partial ownership of an entity. Attributes: <i>financialInterestExists</i> - The 'financialInterestExists'	Optional	0 to more	Container

Element	Description	Required	Multiplicity	Datatype
	attribute can be used to show the existence of a financial interest. This attribute is optional and should be used when further information isn't required by organization.			
FormOfBusinessDescription	A Non-null string description of the form of business.	Optional	0 to 1	Non-null string
OwnershipCategory	The ownership category. Allowed Values: SoleProprietor Partnership Founder	Optional	0 to 1	Restricted
PartnershipCategory	The legal type of business. Allowed Values: Corporation Limited Liability Company Limited Partnership Other	Optional	0 to 1	Restricted
OtherPartnershipCategoryDescription	The legal type of business. The 'OtherPartnershipCategoryDescription' element should be used if the element "PartnershipCategory" is equal to "Other".	Optional	0 to 1	Non-null string
PercentageOfOwnership	The percentage of ownership. Mainly used for privately held companies.	Optional	0 to 1	Number
AnnualCompensationAmount	The annual compensation amount. Attributes: <i>year</i> - The year in which the compensation was earned. <i>type</i> - Valid values are Actual and Estimated. (Allowed values: Actual, Estimated) <i>valuationDate</i> - The date the value was assessed.	Optional	0 to more	Integer

Element	Description	Required	Multiplicity	Datatype
InvestmentAmount	<p><i>currencyCode</i> - The currency code of the amount indicated. Recommended values are ISO 4217 3-letter alphabetic codes. For example, USD for US dollar, CAD for the Canadian dollar, and EUR for the Euro. Valid values are limited to 3-character strings.</p> <p>The amount of money invested in the organization.</p> <p>Attributes:</p> <p><i>currencyCode</i> - The currency code of the amount indicated. Recommended values are ISO 4217 3-letter alphabetic codes. For example, USD for US dollar, CAD for the Canadian dollar, and EUR for the Euro. Valid values are limited to 3-character strings.</p> <p><i>valuationDate</i> - The date the value was assessed.</p>	Optional	0 to 1	Integer
AdditionalInformation	Any additional information about this interest	Optional	0 or 1	Non-null string
Any	Any elements defined by the organization implementing the schema provided those elements are defined in another namespace.	Optional	0 or more	Any datatype

Example:

```

<OtherBusinessOwnership>
  <OwnershipCategory>Partnership</OwnershipCategory>
  <PartnershipCategory>SCorp</PartnershipCategory>
  <OtherPartnershipCategoryDescription>Non-null string
Description</OtherPartnershipCategoryDescription>
  <PercentageOfOwnership>49</PercentageOfOwnership>
  <AnnualCompensationAmount year="2014" type="Actual"
currencyCode="US">10000</AnnualCompensationAmount>

```



```
<AnnualCompensationAmount year="2015" type="Estimated"  
currencyCode="US">120000</AnnualCompensationAmount>  
<InvestmentAmount>120000</InvestmentAmount>  
</OtherBusinessOwnership>
```

8.10 IntellectualProperty

IntellectualProperty relates to intellectual property held.

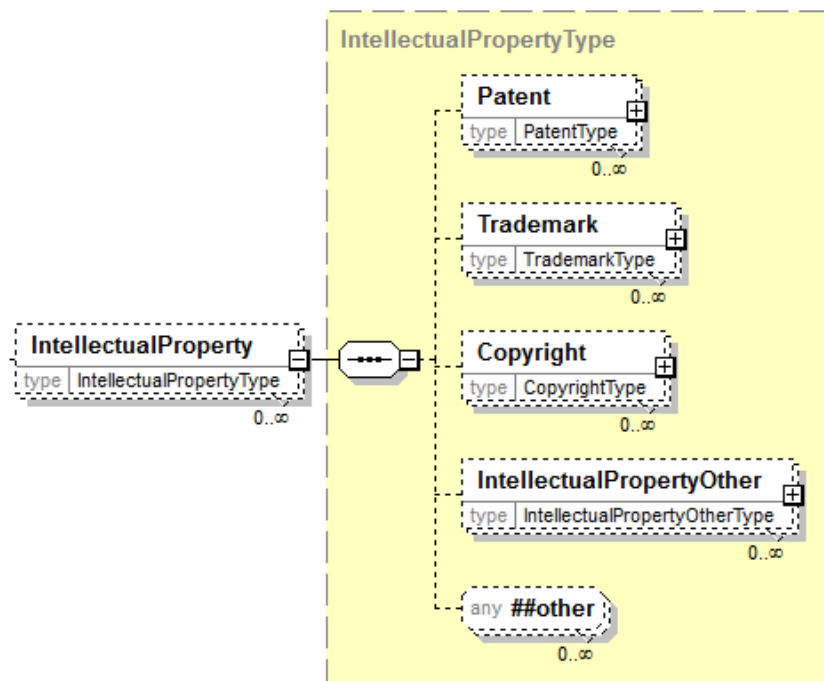

IntellectualProperty Information

Element	Description	Required	Multiplicity	Datatype
IntellectualProperty	Information on intellectual property held, including patents, copyrights, trademarks, and other intellectual property.	Optional	0 to more	Container
Patent	Contains sub-elements that describe information on a patent held and associated income. Attributes: <i>financialInterestExists</i> - The 'financialInterestExists' attribute can be used to show the existence of a financial interest. This	Optional	0 to more	Container

Element	Description	Required	Multiplicity	Datatype
	<p>attribute is optional and should be used when further information isn't required by organization.</p> <p>For more information, see section Patent.</p>			
Trademark	<p>Contains sub-elements that describe a trademark held and associated income.</p> <p>Attributes:</p> <p><i>financialInterestExists</i> - The 'financialInterestExists' attribute can be used to show the existence of a financial interest. This attribute is optional and should be used when further information isn't required by organization.</p> <p>For more information, see section Trademark.</p>	Optional	0 to more	Container
Copyright	<p>Contains sub-elements that describe copyright and associated income.</p> <p>Attributes:</p> <p><i>financialInterestExists</i> - The 'financialInterestExists' attribute can be used to show the existence of a financial interest. This attribute is optional and should be used when further information isn't required by organization.</p> <p>For more information, see section Copyright.</p>	Optional	0 to more	Container
IntellectualPropertyOther	<p>Contains sub-elements that describe intellectual property other than patent, trademark, or copyright and the income associated with that intellectual property.</p> <p>Attributes:</p> <p><i>financialInterestExists</i> - The 'financialInterestExists' attribute can be used to show the existence of a financial interest. This attribute is optional and should be used when further information isn't required by organization.</p> <p>For more information, see section IntellectualPropertyOther.</p>	Optional	0 to more	Container

Element	Description	Required	Multiplicity	Datatype
Any	Any elements defined by the organization implementing the schema provided those elements are defined in another namespace.	Optional	0 or more	Any datatype

Example:

```
<IntellectualProperty>
  <Patent>
    ...
  </Patent>
  <Trademark>
    ...
  </Trademark>
  <Copyright>
    ...
  </Copyright>
  <IntellectualPropertyOther>
    ...
  </IntellectualPropertyOther>
</IntellectualProperty>
```

8.10.1 Patent

Patent includes information on a patent held and associated income.

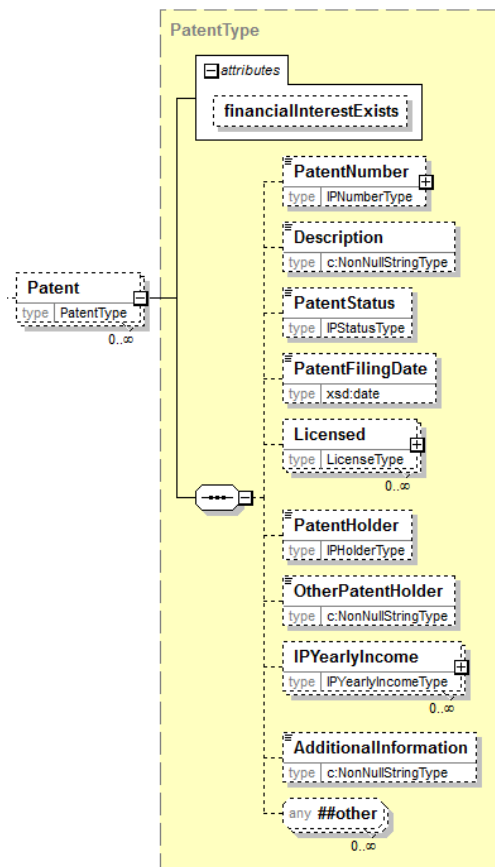

Patent Information

Element	Description	Required	Multiplicity	Datatype
Patent	Contains sub-elements that describe information on a patent held and associated income. Attributes: <i>financialInterestExists</i> - The 'financialInterestExists' attribute can be used to show the existence of a financial interest. This attribute is optional and should be used when further information isn't required by organization.	Optional	0 to more	Container
PatentNumber	The number assigned by the organization approving the patent. Attributes: <i>filingJurisdiction</i> - The jurisdiction where the intellectual property was filed.	Optional	0 to 1	Non-null string
Description	A description of the patent.	Optional	0 to 1	Non-null string
PatentStatus	The status of the intellectual property. Allowed Values: Provisional Pending Issued	Optional	0 to 1	Restricted
PatentFilingDate	The filing date of the patent.	Optional	0 to 1	Date
Licensed	Contains sub-elements that describe licensing of the intellectual property. For more information, see section Licensed.	Optional	0 or more	Container
PatentHolder	Whether the patent is held by an individual or an organization. Allowed Values: Discloser Current Institution Previous Institution Other Organization	Optional	0 to 1	Restricted

Element	Description	Required	Multiplicity	Datatype
OtherPatentHolder	Whether the patent is held by an individual or an organization. The "OtherPatentHolder" element should be used when the value of the element "PatentHolder" is equal to "Other Organization".	Optional	0 to 1	Non-null string
IPYearlyIncome	Contains subelements that describe the yearly income and how the payment to the disclosing individual was processed. For more information, see section IPYearlyIncome.	Optional	0 to more	Container
AdditionalInformation	Any additional information about this interest	Optional	0 or 1	Non-null string
Any	Any elements defined by the organization implementing the schema provided those elements are defined in another namespace.	Optional	0 or more	Any datatype

Example:

```

<Patent>
  <PatentNumber>PTO456-a-123</PatentNumber>
  <Description>Patent for titanium widget</Description>
  <PatentFilingDate>2013-05-28</PatentFilingDate>
  <Licensed>
    <LicenseTitle>Worldwide Widget Manufacturing</LicenseTitle>
    <LicenseDate>2014-06-12</LicenseDate>
  </Licensed>
  <PatentHolder>Discloser</PatentHolder>
  <!--The yearly income has 3 attributes, 'currencyCode', 'type' and 'year'. Multiple years can be
included-->
  <IPYearlyIncome>
    <YearlyIncome currencyCode="US" type="Actual" year="2013">2000</YearlyIncome>
    <PaymentProcessing>direct payment</PaymentProcessing>
  </IPYearlyIncome>
</Patent>

```

8.10.2 Trademark

Trademark includes information on trademark held and associated income.

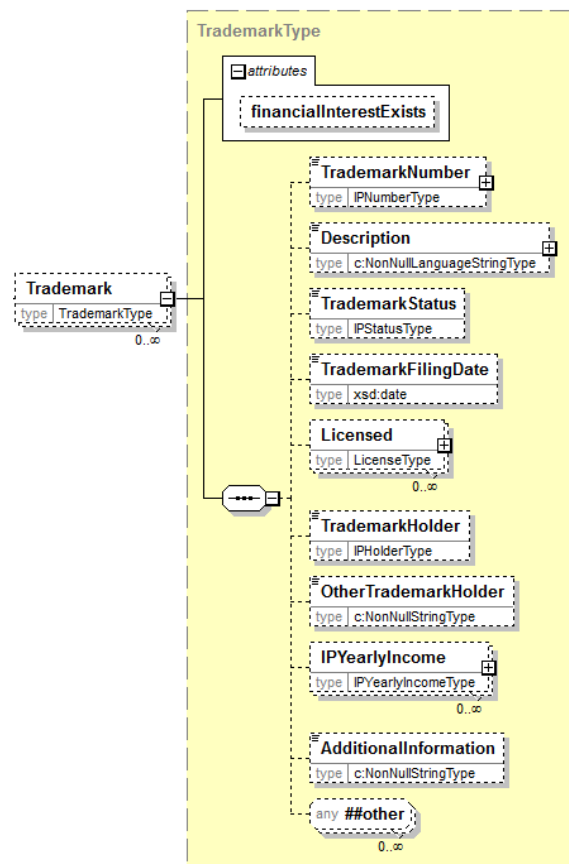

Trademark Information

Element	Description	Required	Multiplicity	Datatype
Trademark	Contains sub-elements that describe a trademark held and associated income. Attributes: <i>financialInterestExists</i> - The 'financialInterestExists' attribute can be used to show the existence of a financial interest. This attribute is optional and should be used when further information isn't required by organization.	Optional	0 to more	Container
TrademarkNumber	The number assigned by the organization approving the trademark. Attributes: <i>filingJurisdiction</i> - The jurisdiction where the intellectual property was filed.	Optional	0 to 1	Non-null string
Description	A description of the trademark.	Optional	0 to 1	Non-null string
TrademarkStatus	The status of the intellectual property. Allowed Values: Provisional Pending Issued	Optional	0 to 1	Restricted
TrademarkFilingDate	The filing date of the trademark.	Optional	0 to 1	Date
Licensed	Contains sub-elements that describe licensing of the intellectual property. For more information, see section Licensed.	Optional	0 or more	Container
TrademarkHolder	Whether the trademark is held by an individual or an organization. Allowed Values: Discloser Current Institution Previous Institution Other Organization	Optional	0 to 1	Restricted
OtherTrademarkHolder	Whether the trademark is held by an individual or an organization. The "OtherTrademarkHolder" element should be used when the	Optional	0 to 1	Non-null string

Element	Description	Required	Multiplicity	Datatype
	value of the element "TrademarkHolder" is equal to "Other Organization".			
IPYearlyIncome	Contains subelements that describe the yearly income and how the payment to the disclosing individual was processed. For more information, see section IPYearlyIncome.	Optional	0 to more	Container
AdditionalInformation	Any additional information about this interest	Optional	0 or 1	Non-null string
Any	Any elements defined by the organization implementing the schema provided those elements are defined in another namespace.	Optional	0 or more	Any datatype

Example:

```

<Trademark>
  <TrademarkNumber>TM-123</TrademarkNumber>
  <TrademarkStatus>Issued</TrademarkStatus>
  <TrademarkFilingDate>2013-06-18</TrademarkFilingDate>
  <Licensed>
    <LicenseTitle>Worldwide Widget Manufacturing</LicenseTitle>
    <LicenseDate>2014-06-12</LicenseDate>
  </Licensed>
  <TrademarkHolder>Previous Institution</TrademarkHolder>
  <IPYearlyIncome>
    <YearlyIncome currencyCode="US" type="Actual" year="2013">2000</YearlyIncome>
    <PaymentProcessing>direct payment</PaymentProcessing>
  </IPYearlyIncome>
</Trademark>

```

8.10.3 Copyright

Copyright includes information on copyright and associated income.

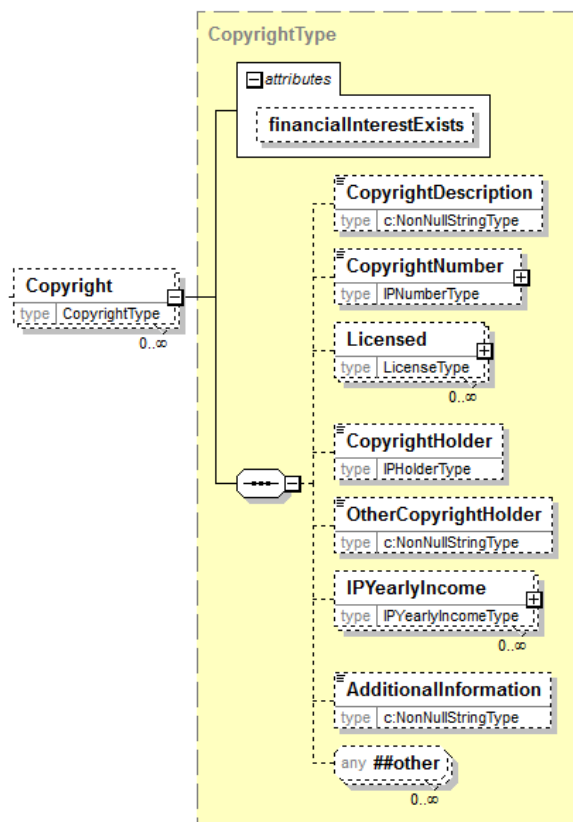

Copyright Information

Element	Description	Required	Multiplicity	Datatype
Copyright	Contains sub-elements that describe copyright and associated income. Attributes: <i>financialInterestExists</i> - The 'financialInterestExists' attribute can be used to show the existence of a financial interest. This	Optional	0 to more	Container

Element	Description	Required	Multiplicity	Datatype
	attribute is optional and should be used when further information isn't required by organization.			
CopyrightDescription	Descriptive information concerning the copyright.	Optional	0 to 1	Non-null string
CopyrightNumber	The number assigned by the copyright approval organization of a specific copyright. Attributes: <i>filingJurisdiction</i> - The jurisdiction where the intellectual property was filed.	Optional	0 to 1	Non-null string
CopyrightHolder	Whether the copyright is held by an individual or an organization. Allowed Values: Discloser Current Institution Previous Institution Other Organization	Optional	0 to 1	Restricted
OtherCopyrightHolder	Whether the copyright is held by an individual or an organization. The "OtherCopyrightHolder" element should be used when the value of the element "CopyrightHolder" is equal to "Other Organization".	Optional	0 to 1	Non-null string
IPYearlyIncome	Contains subelements that describe the yearly income and how the payment to the disclosing individual was processed. For more information, see section IPYearlyIncome.	Optional	0 to more	Container
AdditionalInformation	Any additional information about this interest	Optional	0 or 1	Non-null string
Any	Any elements defined by the organization implementing the schema provided those elements are defined in another namespace.	Optional	0 or more	Any datatype

Example:

```
<Copyright>
  <CopyrightNumber>VA 192-945</CopyrightNumber>
  <CopyrightHolder>Discloser</CopyrightHolder>
  <IPYearlyIncome>
    <YearlyIncome currencyCode="US" type="Actual" year="2013">2000</YearlyIncome>
    <PaymentProcessing>direct payment</PaymentProcessing>
  </IPYearlyIncome>
</Copyright>
```

8.10.4 IntellectualPropertyOther

IntellectualPropertyOther describes intellectual property.

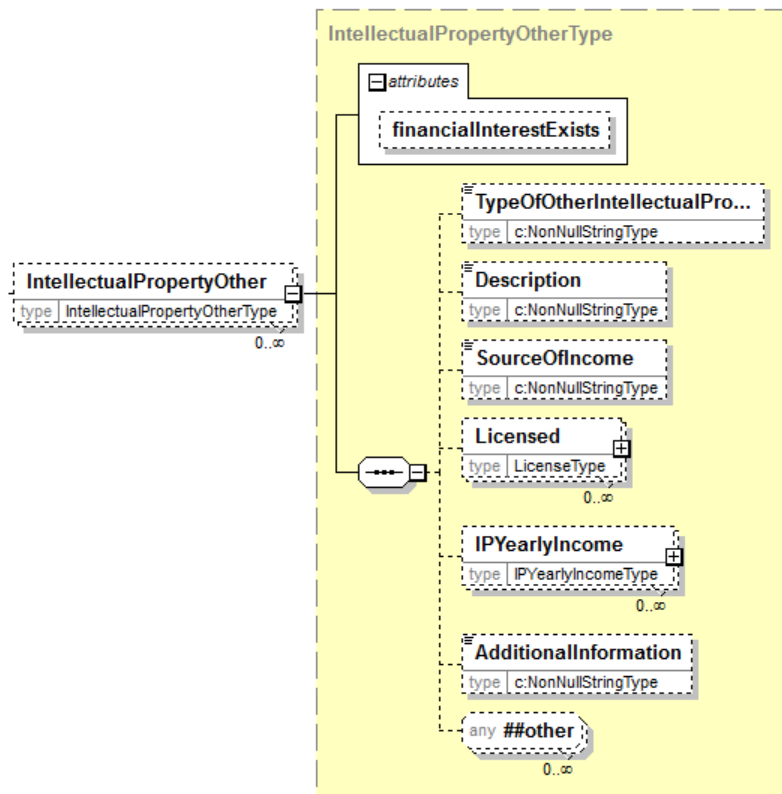

IntellectualPropertyOther Information

Element	Description	Required	Multiplicity	Datatype
IntellectualPropertyOther	Contains sub-elements that describe intellectual property other than patent, trademark, or copyright and the income associated with that intellectual property. Attributes: <i>financialInterestExists</i> - The 'financialInterestExists' attribute can be used to show the existence of a financial interest. This attribute is optional and should be used when further information isn't required by organization.	Optional	0 to more	Container
TypeOfOtherIntellectualProperty	Non-null string field for describing other types of intellectual properties.	Optional	0 to 1	Non-null string
Description	A description of the intellectual property.	Optional	0 to 1	Non-null string
SourceOfIncome	A description of the source of the income derived from the intellectual property.	Optional	0 to 1	Non-null string
Licensed	Contains sub-elements that describe licensing of the intellectual property. For more information, see section Licensed.	Optional	0 or more	Container
IPYearlyIncome	Contains subelements that describe the yearly income and how the payment to the disclosing individual was processed. For more information, see section IPYearlyIncome.	Optional	0 to more	Container
AdditionalInformation	Any additional information about this interest	Optional	0 or 1	Non-null string
Any	Any elements defined by the organization implementing the schema provided those elements are defined in another namespace.	Optional	0 or more	Any datatype

Example:

```
<IntellectualPropertyOther>
  <TypeOfOtherIntellectualProperty>Database</TypeOfOtherIntellectualProperty>
  <Description>Database of patients during trial of ABC Titanium Hip Replacements</Description>
  <SourceOfIncome>Licensing</SourceOfIncome>
  <Licensed>
    <Licensee>
      <EntityReference>E0123</EntityReference>
      <LicenseeDescription>ABC Co</LicenseeDescription>
      <IPYearlyIncome>
        <YearlyIncome currencyCode="US" type="Actual" year="2013">1200</YearlyIncome>
        <PaymentProcessing>direct payment</PaymentProcessing>
      </IPYearlyIncome>
    </Licensee>
    <Licensee>
      <EntityReference>E0234</EntityReference>
      <LicenseeDescription>ZYX Co</LicenseeDescription>
      <IPYearlyIncome>
        <YearlyIncome currencyCode="US" type="Actual" year="2013">800</YearlyIncome>
        <PaymentProcessing>direct payment</PaymentProcessing>
      </IPYearlyIncome>
    </Licensee>
  </Licensed>
  <IPYearlyIncome>
    <YearlyIncome currencyCode="US" type="Actual" year="2013">2000</YearlyIncome>
    <PaymentProcessing>direct payment</PaymentProcessing>
  </IPYearlyIncome>
</IntellectualPropertyOther>
```

8.10.5 IPYearlyIncome

IPYearlyIncome contains subelements that describe the yearly income and how the payment to the disclosing individual was processed.

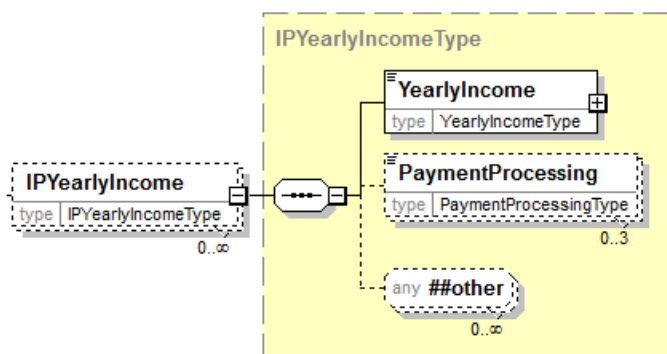

IPYearlyIncome Information

Element	Description	Required	Multiplicity	Datatype
IPYearlyIncome	Contains subelements that describe the yearly income and how the payment to the disclosing individual was processed.	Optional	0 or more	Container
YearlyIncome	The actual or estimated annual income associated with intellectual property. Attributes: <i>year</i> - The year in which the compensation was earned. <i>type</i> - Valid values are Actual and Estimated. (Allowed values: Actual, Estimated) <i>valuationDate</i> - The date the value was assessed. <i>currencyCode</i> - The currency code of the amount indicated. Recommended values are ISO 4217 3-letter alphabetic codes. For example, USD for US dollar, CAD for the Canadian dollar, and EUR for the Euro. Valid values are limited to 3-character strings.	Optional	1	Non-null string

Element	Description	Required	Multiplicity	Datatype
PaymentProcessing	The way payments to the disclosing individual are processed. Valid values are direct payment, payment through home institution, and payment through other organization.	Optional	0 to 3	Non-null string
Any	Any elements defined by the organization implementing the schema provided those elements are defined in another namespace.	Optional	0 or more	Any datatype

9 Sample XML Document

```
<?xml version="1.0" encoding="UTF-8"?>
<FinancialInterestPackages xmlns="http://ns.medbiq.org/Disclosure/v1/"
  xmlns:xsi="http://www.w3.org/2001/XMLSchema-instance"
  xmlns:m="http://ns.medbiq.org/member/v1/"
  xmlns:n="http://ns.medbiq.org/name/v1/"
  xmlns:c="http://ns.medbiq.org/common/v2/"
  xmlns:a="http://ns.medbiq.org/address/v1/"
  xsi:schemaLocation="http://ns.medbiq.org/Disclosure/v1/
  ../../../../Valerie's%20stuff/Xml/Financial%20interest/financialinterest.xsd">
  <IndividualFinancialInterestPackage id="Package1">
    <!--The <Metadata> element is required at the <IndividualFinancialInterestPackage> level and
optional at the <FinancialInterestPackages>
and <FinancialDisclosureInformation> levels. -->
    <!--The <DisclosureProfile> is used to define different types of profiles that can be identified
in order to provide information
for different purposes, i.e. Journal Articles vs. employment conflict of interest.-->
    <Metadata>
      <DisclosureProfile>NEJM Manuscript Submission</DisclosureProfile>
      <CreationInfo>
        <CreationDateTime>2015-02-24T17:43:00</CreationDateTime>
        <UniqueID domain="aamc">aamc1234</UniqueID>
      </CreationInfo>
      <UpdateInfo>
        <UpdateDateTime>2015-02-28T12:19:00</UpdateDateTime>
        <UniqueID domain="aamc">aamc1234</UniqueID>
      </UpdateInfo>
    </Metadata>
    <DisclosingIndividual>
      <UniqueID domain="aamc">aamc1234</UniqueID>
      <UniqueID domain="NEJ">abcd1234</UniqueID>
      <Name>
        <n:Title>Dr.</n:Title>
```

```
<n:GivenName>George</n:GivenName>
<n:FamilyName>Washington</n:FamilyName>
<n:GenerationIdentifier>Jr.</n:GenerationIdentifier>
<n:Degree>MD</n:Degree>
</Name>
<Address>
  <a:Organization>Washington Orthopedic Group</a:Organization>
  <a:StreetAddressLine>2536 West Street</a:StreetAddressLine>
  <a:City>Washington</a:City>
  <a:StateOrProvince>DC</a:StateOrProvince>
  <a:PostalCode>22222</a:PostalCode>
  <a:Country>
    <a:CountryCode>US</a:CountryCode>
  </a:Country>
</Address>
<Email>George.Washington@washorthogroup.com</Email>
<Telephone>
  <m:TelephoneNumber>410-555-1231</m:TelephoneNumber>
  <m:Description>Home</m:Description>
</Telephone>
<Telephone>
  <m:TelephoneNumber>401-555-1232</m:TelephoneNumber>
  <m:Extension>222</m:Extension>
  <m:Description>Office</m:Description>
</Telephone>
</DisclosingIndividual>
<FinancialDisclosureInformation id="Employment">
  <!--This example provides information about an employment interest. -->
  <FinancialRelationshipEntity>
    <OrganizationEntity id="A001">
      <OrganizationName>ABC Associates</OrganizationName>
      <FormOfBusiness>Pharmaceutical Company</FormOfBusiness>
      <Address>
        <a:StreetAddressLine>1600 West Street, NW</a:StreetAddressLine>
        <a:City>Providence</a:City>
```

```

        <a:StateOrProvince>RI</a:StateOrProvince>
        <a:PostalCode>22222</a:PostalCode>
        <a:Country>
            <a:CountryCode>US</a:CountryCode>
        </a:Country>
    </Address>
</OrganizationEntity>
</FinancialRelationshipEntity>
<ProfessionalServices>
    <Employment>
        <DateSpan>
            <BeginDate>1999-01-01</BeginDate>
        </DateSpan>
        <AnnualCompensationAmount>175000</AnnualCompensationAmount>
        <AverageHours>
            <NumberOfHours>40</NumberOfHours>
            <Duration>Week</Duration>
        </AverageHours>
        <FormOfCompensation>Cash</FormOfCompensation>

    </Employment>
</ProfessionalServices>
</FinancialDisclosureInformation>
<FinancialDisclosureInformation id="IndependentContractor">
    <!--This example provides information about a consultancy.-->
    <!--The <Attribution> Element defines who the disclosure relates too. It is an optional
element and if it is blank the attribution is the person who the disclosure pertains.-->
    <Attribution>Self</Attribution>
    <FinancialRelationshipEntity>
        <UniqueID domain="duns">Org123</UniqueID>
        <OrganizationEntity id="A002">
            <OrganizationName>Company A</OrganizationName>
            <FormOfBusiness>Device Manufacturer</FormOfBusiness>
            <ParentCompany>Corporation A</ParentCompany>
            <ContactName>

```

```

        <n:FormattedName>Joy Smith</n:FormattedName>
    </ContactName>
    <Address>
        <a:StreetAddressLine>1600 B Street, NW</a:StreetAddressLine>
        <a:City>Boston</a:City>
        <a:StateOrProvince>MA</a:StateOrProvince>
        <a:PostalCode>22222</a:PostalCode>
        <a:Country>
            <a:CountryCode>US</a:CountryCode>
        </a:Country>
    </Address>
    <Telephone>
        <m:CountryCode>1</m:CountryCode>
        <m:TelephoneNumber>888-888-8881</m:TelephoneNumber>
    </Telephone>
    <Email>info@companya.com</Email>
</OrganizationEntity>
</FinancialRelationshipEntity>
<ProfessionalServices>
    <IndependentContractor>
        <ContractorCategory>Consultant</ContractorCategory>
        <ActivityDateSpan>
            <BeginDate>2013-03-15</BeginDate>
            <EndDate>2014-12-30</EndDate>
        </ActivityDateSpan>
        <!--The content of <AnnualCompensationAmount year="2013" type="Actual"
currencyCode="US"> includes 3 attributes for
            defining the year, type compensation and currency code. Multiple
<AnnualCompensationAmount> elements are allowed
            whenever the element is allowed.-->
        <AnnualCompensationAmount year="2013" type="Actual"
currencyCode="US">5000</AnnualCompensationAmount>
        <AnnualCompensationAmount year="2014" type="Estimated"
currencyCode="US">10000</AnnualCompensationAmount>
        <FormOfCompensation>Equity</FormOfCompensation>

```

```
</IndependentContractor>
</ProfessionalServices>
</FinancialDisclosureInformation>
<FinancialDisclosureInformation id="FiduciaryOfficer">
  <!--In this example, the individual is a Fiduciary Officer of a corporation.-->

  <Metadata>
    <DisclosureProfile>NEJM Manuscript Submission </DisclosureProfile>
    <CreationInfo>
      <CreationDateTime>2015-02-25T09:20:10</CreationDateTime>
      <UniqueID domain="aamc">AAMC456</UniqueID>
    </CreationInfo>
  </Metadata>
  <FinancialRelationshipEntity>
    <UniqueID domain="aamc">Org456</UniqueID>
    <OrganizationEntity id="A010">
      <OrganizationName>ABC Corporation</OrganizationName>
      <FormOfBusiness>Medical Supply Company</FormOfBusiness>
      <ContactName>
        <n:FormattedName>Ben Franklin</n:FormattedName>
      </ContactName>
      <Address>
        <a:StreetAddressLine>100 First Street</a:StreetAddressLine>
        <a:City>Washington</a:City>
        <a:StateOrProvince>DC</a:StateOrProvince>
        <a:PostalCode>22222</a:PostalCode>
        <a:Country>
          <a:CountryCode>US</a:CountryCode>
        </a:Country>
      </Address>
      <Telephone>
        <m:CountryCode>1</m:CountryCode>
        <m:TelephoneNumber>888-888-8882</m:TelephoneNumber>
      </Telephone>
      <Email>departmenta@abc.edu</Email>
```

```

    </OrganizationEntity>
  </FinancialRelationshipEntity>
  <ProfessionalServices>
    <FiduciaryOfficer>
      <Title>Board Member</Title>
      <!--Date span has a begin and end date.  If the end date is not included it is
assumed that the relationship still exists.
      If necessary we can add a choice between <EndDate> and Present.-->
      <DateSpan>
        <BeginDate>2010-01-01</BeginDate>
      </DateSpan>
      <AnnualCompensationAmount>2500</AnnualCompensationAmount>
      <FormOfCompensation>Other</FormOfCompensation>
    </FiduciaryOfficer>
  </ProfessionalServices>
</FinancialDisclosureInformation>
<FinancialDisclosureInformation id="GrantOrContract">
  <!--This example, the designee has received a grant for research.-->

  <Metadata>
    <DisclosureProfile>NEJM Manuscript Submission </DisclosureProfile>
    <CreationInfo>
      <CreationDateTime>2015-03-06T11:20:10</CreationDateTime>
      <UniqueID domain="aamc">aamc1234</UniqueID>
    </CreationInfo>
  </Metadata>
  <Attribution>Self</Attribution>
</FinancialRelationshipEntity>
  <OrganizationEntity id="A003">
    <OrganizationName>ABC Drug Research</OrganizationName>
    <Address>
      <a:City>Bethesda</a:City>
      <a:StateOrProvince>MD</a:StateOrProvince>
      <a:Country>
        <a:CountryCode>US</a:CountryCode>

```



```
        </a:Country>
    </Address>
</OrganizationEntity>
</FinancialRelationshipEntity>
<!--Multiple Grants can be included in a single Financial Disclosure if the grant
organization is the same.-->
<FinancialSupport>
    <GrantOrContract>
        <RecipientName>George Washington</RecipientName>
        <TypeOfRecipient>Individual</TypeOfRecipient>
        <GrantOrContractPurpose>Research</GrantOrContractPurpose>
        <Amount>2500</Amount>
        <DateSpan>
            <BeginDate>2011-01-01</BeginDate>
            <EndDate>2011-12-30</EndDate>
        </DateSpan>
    </GrantOrContract>
    <GrantOrContract>
        <RecipientName>University A</RecipientName>
        <TypeOfRecipient>Institution</TypeOfRecipient>
        <GrantOrContractPurpose>Research</GrantOrContractPurpose>
        <Amount>5000</Amount>
        <DateSpan>
            <BeginDate>2013-01-01</BeginDate>
            <EndDate>2014-12-30</EndDate>
        </DateSpan>
    </GrantOrContract>
</FinancialSupport>
</FinancialDisclosureInformation>
<FinancialDisclosureInformation id="GrantPerson">
    <!--This example, the designee has received a grant for research from an individual.-->

<Metadata>
    <CreationInfo>
        <CreationDateTime>2015-03-23T12:50:10</CreationDateTime>
```

```
        <UniqueID domain="aamc">aamc1234</UniqueID>
    </CreationInfo>
</Metadata>
<Attribution>Self</Attribution>
<FinancialRelationshipEntity>
    <PersonEntity id="P001">
        <Name>
            <n:Title>Dr.</n:Title>
            <n:GivenName>Richie</n:GivenName>
            <n:FamilyName>Rich</n:FamilyName>
        </Name>
        <Address>
            <a:City>Manhattan</a:City>
            <a:StateOrProvince>NY</a:StateOrProvince>
            <a:Country>
                <a:CountryCode>US</a:CountryCode>
            </a:Country>
        </Address>
        <Telephone>
            <m:TelephoneNumber>212-555-1212</m:TelephoneNumber>
        </Telephone>
        <Email>rrich@philanthropy.org</Email>
    </PersonEntity>
</FinancialRelationshipEntity>
<!--Multiple Grants can be included in a single Financial Disclosure if the grant
organization is the same.-->
<FinancialSupport>
    <GrantOrContract>
        <RecipientName>George Washington</RecipientName>
        <TypeOfRecipient>Individual</TypeOfRecipient>
        <GrantOrContractPurpose>Research</GrantOrContractPurpose>
        <Amount>10000</Amount>
        <DateSpan>
            <BeginDate>2014-01-01</BeginDate>
            <EndDate>2014-12-30</EndDate>
```

```
        </DateSpan>
    </GrantOrContract>
</FinancialSupport>
</FinancialDisclosureInformation>
<FinancialDisclosureInformation id="Travel">
    <!--This example, the designee has received reimbursement for travel-->
    <Metadata>
        <CreationInfo>
            <CreationDateTime>2015-03-22T11:20:10</CreationDateTime>
            <UniqueID domain="aamc">aamc1234</UniqueID>
        </CreationInfo>
    </Metadata>
    <Attribution>Self</Attribution>
    <FinancialRelationshipEntity>
        <OrganizationEntity id="A011">
            <OrganizationName>ABC Drug Research</OrganizationName>
            <Address>
                <a:City>Bethesda</a:City>
                <a:StateOrProvince>MD</a:StateOrProvince>
                <a:Country>
                    <a:CountryCode>US</a:CountryCode>
                </a:Country>
            </Address>
        </OrganizationEntity>
    </FinancialRelationshipEntity>
    <FinancialSupport>
        <Travel>
            <Location>San Diego, Ca.</Location>
            <DateSpan>
                <BeginDate>2014-03-12</BeginDate>
                <EndDate>2014-03-17</EndDate>
            </DateSpan>
            <EstimatedOrActualValue currencyCode="US" valuationDate="2014-03-
17">6000</EstimatedOrActualValue>
            <Purpose>Presentation at conference</Purpose>
```

```
        <TravelTypeOfPayment>Reimbursed</TravelTypeOfPayment>
    </Travel>
</FinancialSupport>
</FinancialDisclosureInformation>
<FinancialDisclosureInformation id="Gift">
    <!--This example, the designee has received a gift-->
    <Metadata>
        <CreationInfo>
            <CreationDateTime>2015-03-22T11:20:10</CreationDateTime>
            <UniqueID domain="aamc">aamc1234</UniqueID>
        </CreationInfo>
    </Metadata>
    <Attribution>Self</Attribution>
    <FinancialRelationshipEntity>
        <OrganizationEntity id="A004">
            <OrganizationName>DEF Medical Supply</OrganizationName>
            <Address>
                <a:City>Princeton</a:City>
                <a:StateOrProvince>NJ</a:StateOrProvince>
                <a:Country>
                    <a:CountryCode>US</a:CountryCode>
                </a:Country>
            </Address>
        </OrganizationEntity>
    </FinancialRelationshipEntity>
    <FinancialSupport>
        <Gift>
            <EstimatedValue currencyCode="US" valuationDate="2014-06-06">1000</EstimatedValue>
            <ReceiveDate>2014-06-06</ReceiveDate>
            <Description>Hip Replacement Device</Description>
        </Gift>
    </FinancialSupport>
</FinancialDisclosureInformation>

<FinancialDisclosureInformation id="Stock">
```

```
<!--This example provides information about ownership of stock. -->
<FinancialRelationshipEntity>
  <UniqueID domain="NASDAQ">AAPL</UniqueID>
  <OrganizationEntity id="A005">
    <OrganizationName>Apple Corporation</OrganizationName>
    <FormOfBusiness>IT Company</FormOfBusiness>
    <CompanyCategory>Public</CompanyCategory>
    <Address>
      <a:StreetAddressLine>1 Infinite Loop</a:StreetAddressLine>
      <a:City>Cupertino</a:City>
      <a:StateOrProvince>CA</a:StateOrProvince>
      <a:PostalCode>95014</a:PostalCode>
      <a:Country>
        <a:CountryCode>US</a:CountryCode>
      </a:Country>
    </Address>
    <Telephone>
      <m:TelephoneNumber>408-996-1010</m:TelephoneNumber>
    </Telephone>
    <Email>info@apple.com</Email>
  </OrganizationEntity>
</FinancialRelationshipEntity>
<FinancialStake>
  <Stock>
    <AcquisitionDate>2012-03-15</AcquisitionDate>
    <DivestmentDate>2014-09-12</DivestmentDate>

    <!--
      <NumberOfShares>100</NumberOfShares>
      <ValueOfShares>13000</ValueOfShares>-->

  </Stock>
  <Stock>
    <AcquisitionDate>2013-02-15</AcquisitionDate>
```

```

        <NumberOfShares>200</NumberOfShares>
        <SecurityValue valuationDate="2014-01-01">260000</SecurityValue>
    </Stock>
</FinancialStake>
</FinancialDisclosureInformation>
<FinancialDisclosureInformation id="StockOptions">
    <!--This example provides information about stock options. -->
    <FinancialRelationshipEntity>
        <UniqueID domain="NYSEStockExchange">DEFA</UniqueID>
        <OrganizationEntity id="A006">
            <OrganizationName>DEF Medical Supply</OrganizationName>
            <CompanyCategory>Public</CompanyCategory>
            <Address>
                <a:City>Princeton</a:City>
                <a:StateOrProvince>NJ</a:StateOrProvince>
                <a:Country>
                    <a:CountryCode>US</a:CountryCode>
                </a:Country>
            </Address>
        </OrganizationEntity>
    </FinancialRelationshipEntity>
    <FinancialStake>
        <StockOptions>

            <NumberOfShares>1000</NumberOfShares>
            <OriginalOfferDate>2015-06-30</OriginalOfferDate>
            <OfferPrice>10</OfferPrice>
            <ExpirationDate>2017-01-01</ExpirationDate>
        </StockOptions>
    </FinancialStake>
</FinancialDisclosureInformation>
<FinancialDisclosureInformation id="OtherSecurities">
    <!--This example provides information about types of securities that are not stocks or stock
options. -->

```

```
<FinancialRelationshipEntity>
  <OrganizationEntity id="A007">
    <OrganizationName>ABC Municipal</OrganizationName>
    <Address>
      <a:City>Baltimore</a:City>
      <a:StateOrProvince>MD</a:StateOrProvince>
      <a:Country>
        <a:CountryCode>US</a:CountryCode>
      </a:Country>
    </Address>
  </OrganizationEntity>
</FinancialRelationshipEntity>
<FinancialStake>
  <OtherSecurities>
    <SecurityDescription>Municipal Bonds</SecurityDescription>
    <SecurityValue valuationDate="2014-03-03">5000</SecurityValue>
    <AcquisitionDate>2012-01-12</AcquisitionDate>
    <DivestmentDate>2014-12-03</DivestmentDate>
  </OtherSecurities>
</FinancialStake>
</FinancialDisclosureInformation>

<FinancialDisclosureInformation id="OtherBusinessOwnership">
  <!--This example, the designee is disclosing partial ownership of an entity.-->

  <Metadata>
    <CreationInfo>
      <CreationDateTime>2015-02-25T13:20:10</CreationDateTime>
      <UniqueID domain="aamc">aamc1234</UniqueID>
    </CreationInfo>
  </Metadata>
  <FinancialRelationshipEntity>
    <OrganizationEntity id="A008">
      <OrganizationName>ABC Medical Supply, LLC</OrganizationName>
      <FormOfBusiness>Medical Supply Company</FormOfBusiness>
```

```
<Address>
  <a:City>Philadelphia</a:City>
  <a:StateOrProvince>PA</a:StateOrProvince>
  <a:Country>
    <a:CountryCode>US</a:CountryCode>
  </a:Country>
</Address>
</OrganizationEntity>
</FinancialRelationshipEntity>
<FinancialStake>
  <OtherBusinessOwnership>
    <OwnershipCategory>Partnership</OwnershipCategory>
    <PartnershipCategory>Corporation</PartnershipCategory>
    <OtherPartnershipCategoryDescription>Non-null string
Description</OtherPartnershipCategoryDescription>
    <PercentageOfOwnership>49</PercentageOfOwnership>
    <AnnualCompensationAmount year="2014" type="Actual"
currencyCode="US">10000</AnnualCompensationAmount>
    <AnnualCompensationAmount year="2015" type="Estimated"
currencyCode="US">120000</AnnualCompensationAmount>
    <InvestmentAmount>120000</InvestmentAmount>
  </OtherBusinessOwnership>
</FinancialStake>
</FinancialDisclosureInformation>
<FinancialDisclosureInformation id="Patent">
  <!--This example, the designee is disclosing a patent. The patent has been licensed and
royalties received.-->
</FinancialDisclosureInformation>
<Metadata>
  <CreationInfo>
    <CreationDateTime>2015-02-28T12:19:00</CreationDateTime>
    <UniqueID domain="aamc">AAMC456</UniqueID>
  </CreationInfo>
</Metadata>
<IntellectualProperty>
```



```

    <Patent>
      <PatentNumber>PTO456-a-123</PatentNumber>
      <Description>Patent for titanium widget.</Description>
      <PatentFilingDate>2013-05-28</PatentFilingDate>
      <Licensed>
        <LicenseTitle>Worldwide Widget Manufacturing</LicenseTitle>
        <LicenseDate>2014-06-12</LicenseDate>
      </Licensed>
      <PatentHolder>Discloser</PatentHolder>
      <!--The yearly income has 3 attributes, 'currencyCode', 'type' and 'year'. Multiple
years can be included-->
      <IPYearlyIncome>
        <YearlyIncome currencyCode="US" type="Actual" year="2013">2000</YearlyIncome>
      </IPYearlyIncome>
      <IPYearlyIncome>
        <YearlyIncome currencyCode="US" type="Estimated" year="2014">2000</YearlyIncome>
      </IPYearlyIncome>
    </Patent>
  </IntellectualProperty>
</FinancialDisclosureInformation>
<FinancialDisclosureInformation id="Trademark">
  <!--This example, the designee is disclosing a trademark. The trademark has been licensed
and royalties received.-->

  <Metadata>
    <CreationInfo>
      <CreationDateTime>2015-02-28T12:19:00</CreationDateTime>
      <UniqueID domain="aamc">AAMC456</UniqueID>
    </CreationInfo>
  </Metadata>
  <IntellectualProperty>
    <Trademark>
      <TrademarkNumber>TM-123</TrademarkNumber>
      <TrademarkStatus>Issued</TrademarkStatus>
      <TrademarkFilingDate>2013-06-18</TrademarkFilingDate>
    </Trademark>
  </IntellectualProperty>

```

```

        <Licensed>
          <LicenseTitle>Worldwide Widget Manufacturing</LicenseTitle>
          <LicenseDate>2014-06-12</LicenseDate>
        </Licensed>
        <TrademarkHolder>Previous Institution</TrademarkHolder>
        <IPYearlyIncome>
          <YearlyIncome>1000</YearlyIncome>
        </IPYearlyIncome>
        </Trademark>
      </IntellectualProperty>
    </FinancialDisclosureInformation>
    <FinancialDisclosureInformation id="Copyright">
      <!--This example, the designee is disclosing a copyright.  There are 2 Yearly Incomes, one
      actual and one estimated.-->

      <Metadata>
        <CreationInfo>
          <CreationDateTime>2015-03-22T12:19:00</CreationDateTime>
          <UniqueID domain="aamc">AAMC456</UniqueID>
        </CreationInfo>
      </Metadata>
      <IntellectualProperty>
        <Copyright>
          <CopyrightNumber>VA 192-945</CopyrightNumber>
          <CopyrightHolder>Discloser</CopyrightHolder>
          <IPYearlyIncome>
            <YearlyIncome currencyCode="US" type="Actual" year="2013">50</YearlyIncome>
          </IPYearlyIncome>
          <IPYearlyIncome>
            <YearlyIncome currencyCode="US" type="Estimated" year="2014">100</YearlyIncome>
          </IPYearlyIncome>
        </Copyright>
      </IntellectualProperty>
    </FinancialDisclosureInformation>
    <FinancialDisclosureInformation id="IntellectualPropertyOther">

```

<!--This example shows intellectual property that isn't a patent, copyright or trademark.
This example shows a database.-->

```

<Metadata>
  <CreationInfo>
    <CreationDateTime>2015-03-23T12:19:00</CreationDateTime>
    <UniqueID domain="aamc">AAMC456</UniqueID>
  </CreationInfo>
</Metadata>
<IntellectualProperty>
  <IntellectualPropertyOther>
    <TypeOfOtherIntellectualProperty>Database</TypeOfOtherIntellectualProperty>
    <Description>Database of patients during trial of ABC Titanium Hip
Replacements.</Description>
    <SourceOfIncome>Licensing</SourceOfIncome>
    <IPYearlyIncome>
      <YearlyIncome>1000</YearlyIncome>
    </IPYearlyIncome>
  </IntellectualPropertyOther>
</IntellectualProperty>
</FinancialDisclosureInformation>
</IndividualFinancialInterestPackage>

```

<IndividualFinancialInterestPackage id="Package2">
<!--This example shows another Financial Interest Package where only the information that a
financial relationship exists -->

```

<Metadata>
  <CreationInfo>
    <CreationDateTime>2015-04-15T15:20:01</CreationDateTime>
    <UniqueID domain="AAMC">Smith.John</UniqueID>
  </CreationInfo>
</Metadata>
<DisclosingIndividual>
  <Name>
    <n:GivenName>John</n:GivenName>
    <n:FamilyName>Smith</n:FamilyName>
  </Name>

```

```
</Name>
<Address><a:StreetAddressLine>1212 Ivory Lane</a:StreetAddressLine>
  <a:City>Boston</a:City>
  <a:StateOrProvince>MA</a:StateOrProvince>
  <a:PostalCode>22222</a:PostalCode>
  <a:Country>
    <a:CountryName>United States</a:CountryName>
  </a:Country>
</Address>
<Email>John.Smith@abc.org</Email>
<Telephone>
  <m:TelephoneNumber>301-555-1212</m:TelephoneNumber>
</Telephone>
</DisclosingIndividual>
<FinancialDisclosureInformation id="EmptyContent">
  <FinancialRelationshipEntity>
    <OrganizationEntity id="A009">
      <OrganizationName>ABC Corporation</OrganizationName>
      <Address>
        <a:StreetAddressLine>567 Security Boulevard</a:StreetAddressLine>
        <a:City>Baltimore</a:City>
        <a:StateOrProvince>MD</a:StateOrProvince>
        <a:PostalCode>22222</a:PostalCode>
        <a:Country>
          <a:CountryCode>US</a:CountryCode>
        </a:Country>
      </Address>
    </OrganizationEntity>
  </FinancialRelationshipEntity>
  <FinancialStake>
    <!--This is an example where information is not gathered. The data model just tells the
application that a stock exists. -->
    <Stock financialInterestExists="true"/></FinancialStake>
  </FinancialDisclosureInformation>
</IndividualFinancialInterestPackage>
```

</FinancialInterestPackages>

10 References

Address

ANSI /MEDBIQ PP.10.1-2008 Address Specifications and Description Document. MedBiquitous Website. http://www.medbiq.org/working_groups/professional_profile/AddressSpecification.pdf . Accessed June 24, 2015.

Name

ANSI /MEDBIQ PP.10.1-2008 Name Specifications and Description Document. MedBiquitous Website. http://www.medbiq.org/working_groups/professional_profile/NameSpecification.pdf . Accessed June 24, 2015.

Professional Profile

ANSI/MEDBIQ PP.10.1-2008, Healthcare Professional Profile. MedBiquitous Website. http://www.medbiq.org/std_specs/standards/index.html#HCProfProfile . Accessed June 24, 2015.